



An ACS Brand

WALL MOUNT AIR CONDITIONER PRODUCT DATA SHEET

11+ EER 1.5-6 Ton Vertical Packaged Wall Mount Air Conditioners

Single Stage Models:

EAH1020A, EAH1024A, EAH1030A, EAH1036A,
EAH1042A, EAH1048A, EAH1060A & EGH1072A

2-Stage Models:

EAH2024A, EAH2030A, EAH2036A, EAH2042A,
EAH2048A, EAH2060A & EGH2072A

General Description

Used to cool electronic and communication equipment shelters, modular buildings, classrooms and a variety of commercial/ industrial structures, Eubank® wall mount air conditioners are versatile problem solvers for a wide range of conditions and applications. Due to the high internal heat load in applications such as electronic equipment shelters, cooling is required even when outside temperatures drop below 60°F (15°C). Eubank air conditioners have the necessary controls and components for operation during these (less than 60°F [15°C]) temperatures. All models use the non-ozone depleting R-454B refrigerant.

All Eubank wall mount air conditioners are available with an optional factory installed economizer. When ambient conditions are cool and dry, the economizer uses outside air to cool the shelter. The economizer provides temperature control, energy cost savings, and increased reliability by decreasing the operating hours of the compressor and the condenser fan. To insure proper operation and optimum performance, all economizers are non-removable, factory installed and tested. In addition, factory and field installed accessories can be used to meet specific requirements.

► High Efficiency Models

Eubank's energy efficient wall mount air conditioners meet or exceed the US Department of Energy's Btu/h efficiency levels of 11 EER for units less than 65,000 BTU/h cooling capacity and 10 EER for units larger than 65,000 BTU/h. Electronically commutated indoor fan motors combined with highly efficient scroll compressors result in these higher Energy Efficiency Ratios (EER's).



EAH1036A w/Economizer



Features and Benefits

Built-In Energy Savings

- Optional Factory Installed Economizer
- Features and Options to Meet Any Budget and Efficiency Requirements
- Available EER of up to 11.50

Next Generation R-454B Refrigerant

- 78% Lower GWP than R-410A
- Non-Ozone Depleting Refrigerant
- Synthetic Lubricant
- Reduced Compressor Wear

High Efficiency and Reliability

- High Efficiency Compressor and Lanced Coil Fins
- High Pressure Switch Protection
- Liquid Line Temperature Monitoring & Control
- Suction Line Temperature monitoring & Control

Ease of Installation and Service

- Side Access Panels for Power Connections
- Built-In Mounting Flanges and Internal Disconnect
- Standard Access Valves and Filters, Status LEDs

Safety Listed and Energy Certified

All Eubank air conditioners conform to UL/CSA standard 60335-1 and 60335-2-40 and CAN/CSA C22.2, No. 236-11 Ed.4. For energy efficiency and performance, the units are tested and rated in accordance to the ANSI/ARI (Air-Conditioning and Refrigeration Institute) Standard 390- 2003 (Single Package Vertical Units). All units meet or exceed the efficiency requirements of ANSI/ASHRAE/IESNA 90.1.2016. Eubank air conditioners are commercial units and are not intended for use in residential applications.

Standard Features

➤ Designed for Operation in Low Ambient Conditions

- Low ambient control cycles condenser fan to maintain proper refrigerant pressures. Allows operation in mechanical cooling (compressor) of our standard air conditioners down to 0°F (-7°C). Note: low temperature operation is affected by ambient conditions, e.g. wind and humidity.
- Three minute by-pass of the low pressure sensor for start-up of compressor when outdoor temperatures are below 55°F (13°C).
- Optional economizer.

➤ Designed for Operation on Generator Power

- All Eubank single & three phase air conditioners are designed to operate on Generator Power. See *Summary Electrical Ratings* for your specific model

➤ High Efficiency

- High efficiency compressor.
- Lanced fins standard on all evaporator and condenser coils.

➤ Remote Alarm Capability

- Dry contacts can be used for remote alarm or notification upon air conditioner lockout.

➤ Built-in Reliability

- High pressure switch and low pressure sensor with lockout protects refrigerant circuit.
- Built in 3-minute delay on break anti-short cycle protection.

➤ Ease of Service

- Service access valves are standard.
- Standard 2" (50 mm) pleated filter with a MERV rating of 8 changeable from outside.
- All major components are readily accessible.
- Front Control Panel allows easy access and complies with NEC clearance codes on redundant side-by-side systems.
- LEDs indicate operational status and fault conditions.
- Foil backed insulation on the indoor air path.
- A minimum position potentiometer that can be adjusted to prevent the economizer damper from closing completely. This control ensures that whenever the evaporator fan is operating, fresh air is being introduced into the building.

➤ Thermal Expansion Valve

- Improves performance in hot ambient temperatures.

➤ Rugged Construction

- Copper tube, aluminum fin evaporator & condenser coils.
- Field or factory installed heaters on discharge side of evaporator coil (optional)
- Baked on neutral beige finish over galvanized steel for maximum cabinet life. (Other finishes are available.)
- A sealed condenser fan motor resists sand and corrosion.

➤ Ease of Installation

- Sloped top with flashing eliminates need of rainhood.
- Built-in mounting flanges facilitate installation and minimize chance of water leaks.
- Factory installed disconnect (internal circuit breaker(s)).
- Single Point Power Entry Complies with latest edition of U.L. Standard 60335-2-40.
- Side access panels on economizer models for easy access to electrical connections.
- A phase monitor is standard on all 3-Phase units to continuously measure the voltage of each of the three phases. Protects unit from voltage imbalance including phase loss and phase reversal.

Factory Installed Economizer

Eubank's wall mount air conditioners have been the industry standard since their introduction in 1986. Tens of thousands of Eubank air conditioners are in operation from the metropolitan areas of North America to the deserts of the Mid-East to the Siberian tundra. Here's how the economizer works:

On a signal from the wall mounted indoor thermostat that cooling is required, either mechanical cooling with the compressor or free cooling with the optional economizer is provided. A factory installed enthalpy controller determines whether the outside air is sufficiently cool and dry to be used for cooling. If suitable, the compressor is locked out and the economizer damper opens to bring in outside air. Integral pressure relief allows the interior air to exit the shelter, permitting outside air to enter the shelter. The temperature at which the economizer opens is adjustable from 63°F (17°C) at 50% Relative Humidity to 73°F (23°C) at 50% Relative Humidity.

After the enthalpy control has activated and outside air is being brought into the building, the mixed air sensor measures the temperature of the air entering the indoor blower and then modulates the economizer damper to mix the right proportion of cool outside air with warm indoor air to maintain 50-63°F (10 - 17°C) air being delivered to the building. This prevents shocking the electronic components with cold outside air. The compressor is not permitted to operate when the economizer is functioning.

If the outside air becomes too hot or humid, the economizer damper closes completely, or to a field selectable minimum open position, and mechanical cooling is activated.

In all Eubank air conditioners, the supply air flow in the economizer mode is the same or greater than the rated air flow. (The rated air flow is the AHRI certified air flow when the unit is in mechanical cooling.) The “full flow” economizer reduces electrical costs by maximizing the use of outside air for cooling.

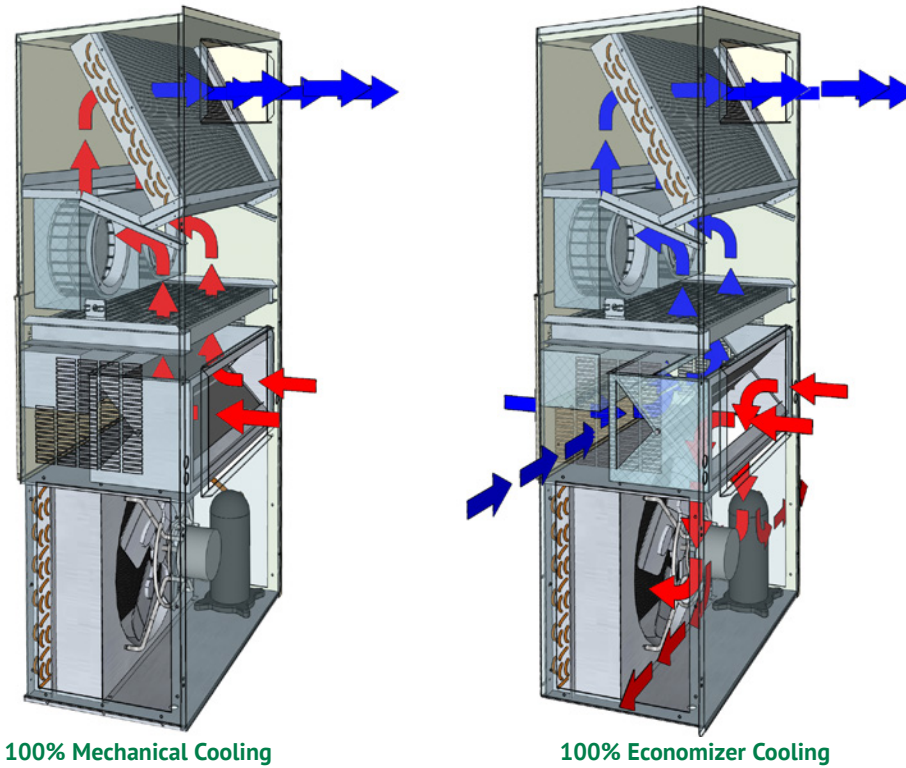

*Artists rendering may vary from actual production units.

Savings with an Economizer

The following table shows the annual electrical cost of cooling a 10 ft. x 20 ft. x 9 ft. (3m x 6m x 2.7m) shelter in twelve cities in the US. Costs are shown for an air conditioner without an economizer, for an air conditioner with an economizer and the savings. The savings do not include any demand charges. The savings are based on the electrical usage of a five ton air conditioner and an electric rate of \$.11 per kilowatt-hour, the approximate average commercial rate in the US.

Hours of Operation	Atlanta, GA	Boston, MA	Chicago, IL	Dallas, TX	Denver, CO	Houston, TX
Annual Compressor & Condenser Motor Run Time without Economizer (Hrs.)	6,176	6,016	6,018	6,282	6,022	6,299
Annual Compressor & Condenser Motor Run Time with Economizer (Hrs.)	3,456	1,947	2,106	4,062	1,930	4,495
Run Time Savings with the Economizer (Hrs.)	2,720	4,069	3,912	2,220	4,092	1,804
Annual Costs Saving (\$) of 11.0 EER unit with an Economizer						
Annual Operating Cost 11.0 EER Unit without Economizer (\$)	\$3,150	\$3,068	\$3,069	\$3,204	\$3,072	\$3,212
Annual Operating Cost 11.0 EER with Economizer	\$2,071	\$1,459	\$1,525	\$2,323	\$1,454	\$2,496
Annual Savings using 11.0 EER Unit with Economizer	\$1,079	\$1,609	\$1,544	\$881	\$1,454	\$716

Hours of Operation	Los Angeles, CA	Miami, FL	Phoenix, AZ	Pittsburgh, PA	Seattle, WA	St. Louis, MO
Annual Compressor & Condenser Motor Run Time without Economizer (Hrs.)	6,105	6,434	6,473	6,026	5,999	6,120
Annual Compressor & Condenser Motor Run Time with Economizer (Hrs.)	3,121	6,062	4,799	2,172	1,093	2,896
Run Time Savings with the Economizer (Hrs.)	2,984	372	1,674	3,854	4,906	3,224
Annual Costs Saving (\$) of 11.0 EER unit with an Economizer						
Annual Operating Cost 11.0 EER Unit without Economizer (\$)	\$3,114	\$3,282	\$3,302	\$3,073	\$3,060	\$3,122
Annual Operating Cost 11.0 EER with Economizer	\$1,926	\$3,133	\$2,636	\$1,550	\$1,114	\$1,846
Annual Savings using 11.0 EER Unit with Economizer	\$1,188	\$148	\$666	\$1,523	\$1,946	\$1,275

Shelter Metrics:

- 10' x 20' x 9' building
- Internal heat gain (electronics load): 12,000 watts.
- Building surface area (excluding floor area): 740 ft²
- R-Value of walls and ceiling: R-12
- Internal shelter temperature (Thermostat set point): 75°F

Air Conditioner Metrics:

- Economizer setting: 63°F (dry bulb or enthalpy sensor)
- A/C unit capacity: 60,000 BTUH (5 tons) with 1-stage compressor
- Nominal EER (unit efficiency): 11.0
- Cost of power: \$.11 per KWH

Options for Outside Air for Ventilation

Eubank offers ventilation packages for every budget and requirement.

► Configuration “C”: Up to 100% Modulating Economizer

The economizer reduces the cost of air conditioning by using outside air when acceptable to cool the room (Free Cooling). The factory installed Eubank® economizer has integral pressure relief.

Control Board Logic: Upon a “Call for Cooling”, the unit controller calculates whether the HVAC operates in economizer mode or mechanical cooling mode based on outdoor temperature (dry bulb) or temperature/humidity (enthalpy). When outdoor conditions are favorable for economizer cooling, the damper drives open and modulates to maintain a 55°F mixed air temperature through the supply grille. When outdoor conditions are not favorable for economizer cooling, the economizer damper remains closed, and the HVAC unit will operate in mechanical cooling mode.

Additional Features Provided with Economizer Options:

Hydrogen Fault Input: When 24VAC is applied to the H_FLT input, the unit controller forces the damper to open 100% for emergency ventilation. The compressor does not operate during Hydrogen Fault/Emergency Ventilation. Thermostat must provide the fan “G” signal to HVAC to activate the indoor blower.

Forced Mechanical Cooling: When 24VAC is applied to the FC input of the unit controller, the economizer damper is forced closed, and the HVAC will operate in mechanical cooling mode. This is considered as economizer override in the event economizer cooling is not sufficient for the heat load. Thermostat must provide the fan “G” signal to HVAC to activate the indoor blower.

Economizer Status: The unit controller provides status output based on the economizer functionality

When used with minimum position potentiometer (optional), the Eubank® economizer can meet requirements of ASHRAE Std. 62.

► Configuration “D”: Two-Position Motorized Fresh Air Damper w/Pressure Relief Ventilation

Control Board Logic: The unit controller allows the position of the “D” damper to be set for desired outside air intake from fully closed to fully open. The unit controller configuration menu allows the user to set the position from 20 (2VDC / Closed) to 100 (10VDC 100% open). The damper position can be adjusted in 1VDC increments to any position from closed to 100% open as required.

Operation: Anytime the indoor blower operates, the damper drives open to the position selected in the unit controller. When the indoor blower stops operation the motorized damper spring returns to the fully closed position.

Note: This circuit does not interrupt the compressor or heater operation.

► Configuration “E”: Two-Position Motorized Fresh Air Damper w/Pressure Relief Ventilation & Independent Control

Control Board/Factory Installed Relay Logic: The unit controller allows the position of the “E” damper to be set for desired outside air intake from fully closed to fully open. The unit controller configuration menu allows the user to set the position from 20 (2VDC / Closed) to 100 (10VDC 100% open). The damper position can be adjusted in 1VDC increments to any position from closed to 100% open as required.

Operation: Upon a “Call for Motorized damper” via a 24V signal from an external user-installed device, the motorized damper opens to the position selected in the unit controller and the indoor blower operates. A 24VAC signal {sourced from LVTB 24VAC “R” and supplied through a user-provided Normally Open (NO) contact} activates (opens) the Motorized Damper and connected Relief Damper. When the 24VAC signal is removed, the motorized damper spring returns to the fully closed position and the indoor blower stops operation. The motorized damper Does NOT open when there is a call for the indoor fan (G).

Note: This circuit does not interrupt the compressor or heater operation.

► Configuration “F”: No Free Cooling, 100%- Damper Opening, Emergency Ventilation Only w/Pressure Relief and Independent Control

Upon a “Call for emergency ventilation”, from an external user-provided device; the motorized damper opens to 100% open position and the indoor blower is forced to operate.

Note: This circuit interrupts the compressor and heater operation and forces the indoor blower and damper to operate during emergency ventilation mode.

➤ **Configuration “H”: GreenWheel® ERV Energy Recovery Ventilator (Optional only for EAH1030/2030 - EAH1060/2060)**

This option includes the GreenWheel, independently controlled intake and exhaust blowers with manually adjustable dampers and an outside air filter. See the Eubank EAH Air Conditioner Installation and Operation Manual for setup and configuration details.

How It Works - During the summer, cool dry air from the classroom is exhausted through the GreenWheel ERV to the outside. As the air passes through the rotating wheel, the desiccant becomes cooler and drier. Simultaneously, hot humid air is being pulled across the rotating wheel. The cool, dry desiccant absorbs moisture and heat from the incoming air. The cooler, drier air is mixed with the return air from the classroom and distributed throughout the room.

In the winter, warm moist air is exhausted through the GreenWheel ERV to the outside. As the air passes through the rotating wheel, the desiccant becomes warmer and absorbs moisture. Simultaneously, cold dry air is being pulled across the rotating wheel. The cold, dry air absorbs heat and moisture from the desiccant. The warmed air is mixed with the return air from the classroom and distributed throughout the room.

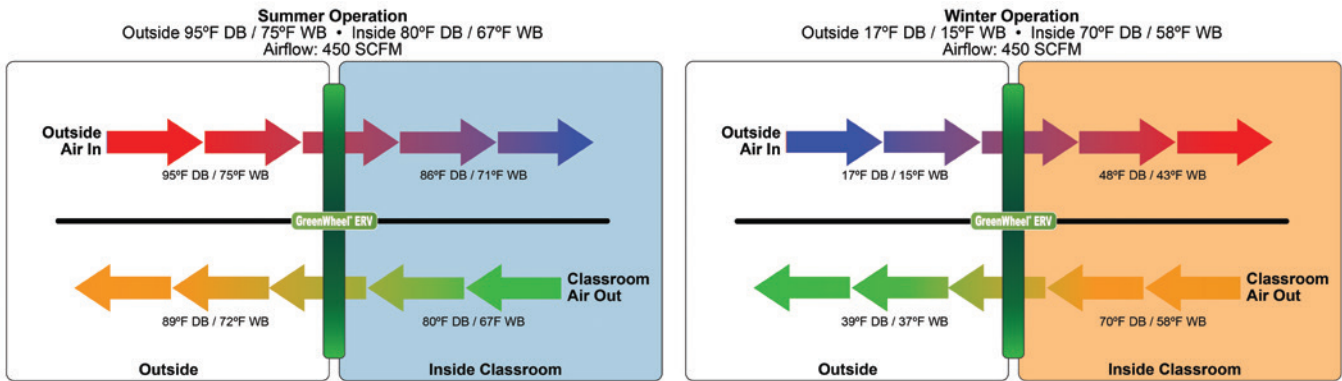
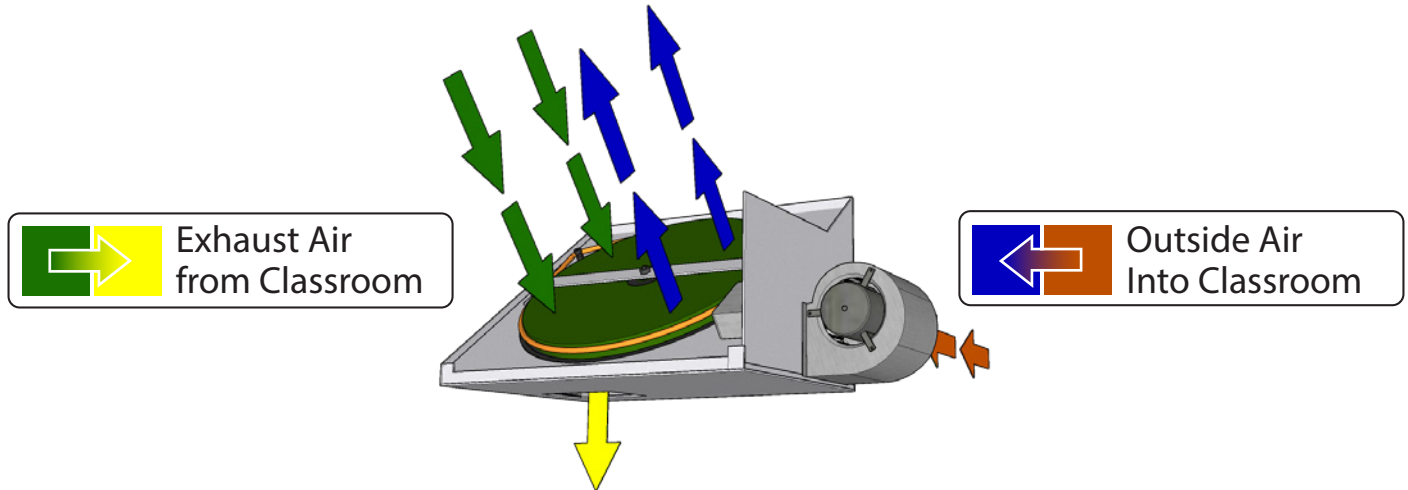

For performance of the GreenWheel ERV at conditions other than those shown, please contact your Eubank representative or the factory.

➤ **Configuration “N”: Manual Fresh Air Damper (Standard)**

Barometric damper capable of up to 15% of the air conditioner’s total rated airflow of outside air; field adjustable, no internal pressure relief.

➤ **Configuration “T”: Title 24 Compliant Economizer & Controls**

California Title 24 compliant economizer and associated controls.

Controllers and Thermostats

➤ **Thermostats and Controllers for Single Stage and 2-Stage Air Conditioners**

See the *Marvair Thermostats and Controllers Product Data Sheet* for the thermostats and controllers for use with Eubank air conditioners.

Supply/Return Grilles

► Supply Grilles

For EAH1020A, EAH1024A, EAH1024A "B2" – 20" x 8" (508 mm x 203 mm).....	P/N 80674
For EAH1030A, EAH1030A "B2", EAH1036A, EAH1036A "B2" – 28" x 8" (711 mm x 203 mm)	P/N 80675
For EAH1042A, EAH1048A EAH1060A – 30" x 10" (762 mm x 254 mm).....	P/N 80676
For EAH2060A, EGH1072A & EGH2072A Reverse Flow – 30" x 16" (762 mm x 406 mm).....	P/N 93197
For EGH1072A & EGH2072A – 30" x 10" (762 mm x 254 mm).....	P/N 80676

► Return Grilles

For EAH1020A, EAH1024A, EAH2024A & EAH1024A "B2" – 20" x 12" (508 mm x 305 mm).....	P/N 80677
For EAH1030A, EAH1036A, EAH2030A, EAH2036A & EAH1030A "B2", EAH1036A "B2" – 28" x 14" (711 mm x 356 mm)	P/N 80678
For EAH1042A, EAH1048A EAH1060A, EAH2042A, EAH2048A, EAH2060A, EAH2072A– 30" x 16" (762 mm x 406 mm)	P/N 80679
For EAH2060A, EGH1072A & EGH2072A Reverse Flow – 30" x 10" (762 mm x 254 mm).....	P/N 93198
For EGH1072A & EGH2072A – 30" x 16" (762 mm x 406 mm).....	P/N 80679

► Return Filter Grilles

Used when filter must be changed from the interior. Not recommended for economizer equipped air conditioners.

Note: Filter used in Return Filter Grille is 1" (25 mm) thick.

For EAH1020A, EAH1024A, EAH1024A "B2" – 20" x 12" (508 mm x 305 mm).....	P/N 80671
1" Replacement Filter.....	P/N 91983
For EAH1030A, EAH1030A "B", EAH1036A, EAH1036A "B" – 28" x 14" (711 mm x 356 mm).....	P/N 80672
1" Replacement Filter.....	P/N 80769
For EAH1042A, EAH1048A, EAH1060A, EAH2042A, EAH2048A, EAH2060A 30" x 16" (762 mm x 406 mm)	P/N 80673
1" Replacement Filter.....	P/N 80140

Options

Eubank air conditioners were designed and are built to stringent requirements of the communications/electronic shelter. Applications occur that have special requirements. Numerous options are available to meet these special needs.

► Hard Start Kit

Used on single phase equipment to give the compressor higher starting torque under low voltage conditions.

► Electric Reheat Dehumidification

Allows the electric heat to operate simultaneously with cooling. **Note:** The electrical characteristics and requirements of air conditioners with the dehumidification option are different from standard air conditioners. Refer to the appropriate Summary Rating Charts for the electrical characteristics of units with Electric Reheat. Units with reheat require a thermostat and a dehumidistat for proper operation.

► Hot Gas Reheat (HGR) for Dehumidification

A Hot Gas Reheat coil and controls allow the indoor humidity of the controlled environment to be maintained at or below a certain humidity set point. These units do not have the ability to add humidity to the room. Dehumidification is achieved by operating mechanical cooling in conjunction with a hot gas reheat coil.

► Protective Coating Packages

Coated Coils: Either the condenser or evaporator coil can be coated. For harsh conditions, e.g., power plants, paper mills or sites where the unit will be exposed to salt water, the coils should be coated.

Coastal Environmental Package: This package includes:

- Corrosion resistant fasteners,
- Coated condenser motor, motor bracket and condenser fan,
- Insitu coating applied to all exposed internal copper and metal in the in the condenser section, and
- A protective coating on the condenser coil.

All Coat Package: Includes the same features as the *Coastal Environmental Package* and adds:

- Insitu coating to the evaporator coil and all associated piping,
- All exterior and interior components and sheet metal.

Note 1: The insulated internal sheet metal and the internal control box are not coated.

Note 2: The corrosion prevention coating can not be applied to stainless steel.

► Wall Mount Air Conditioner Transition Curb

Used when replacing a unit with different size supply/return openings. Contact your Eubank sales representative for application details

➤ **High Filtration**

Selected units are built with larger blowers/motors for use with factory installed two inch (51 cm) higher efficiency filters with MERV ratings of 11 and 13 when tested to ASHRAE 52.2. Ultra high filtration material that removes most airborne mold, spores and dust. Units with economizers have a prefilter on the outside air. Contact your Eubank representative for specific models.

➤ **Center Supply/Top Return Configuration**

Location of Supply and Return openings are reversed. See dimensional drawings.

➤ **Cabinet Color**

The standard colors are Marvair® beige, white, gray and Carlsbad Canyon (brown). The standard cabinet's sides, top and front panels are constructed of 20 gauge painted steel. Contact your Eubank representative for standard color chips. Custom colors are also available; contact Eubank for details.

Two stainless steel cabinet constructions are available:

- **Stainless Steel Exterior (Option "5"):** This option replaces all standard exterior painted surfaces with stainless steel. This option also replaces the standard unpainted compressor base of the unit and exterior cabinet screws with stainless steel. No other standard construction surfaces are stainless steel in this option, unless listed in this description. Back panel is not stainless steel with this option. This option is designed to give a more economical alternative to full stainless steel, and still offer an enhanced level of protection. For further corrosion protection, please see our "A" offering at full stainless on all metal components.
- **Stainless Steel Unit (Option "A"):** This option replaces all interior and exterior steel sheet metal parts with stainless steel. All galvanized and painted steel surfaces found in the standard unit are stainless steel with this option. All cabinet screws are stainless steel. No other standard construction surfaces are stainless steel, unless listed in this description. This option is designed to give our most robust protection against steel corrosion.

➤ **Extended Warranty**

A first-year labor (Silver), and a two-year labor (Gold) are available. See www.EubankWallMount.com for optional warranty details.

➤ **Dirty Filter Indicator**

A factory installed option that measures the difference in pressure across the internal filter and illuminates a LED (green board only, ModBus notification with PLC equipped units). when the pressure exceeds the desired difference.

➤ **Compressor Sound Blanket**

To reduce sound of compressor.

➤ **Lockable Disconnect (Internal Circuit Breaker(s)) Access Cover Plate**

The access plate to the internal service disconnect can be equipped with a lockable cover.

➤ **Washable Filter**

Spun aluminum construction allows cleaning of filters with water.

➤ **Compressor Locations**

Most EAH air conditioners can be built with the compressor on the opposite side to facilitate service access when two units are installed side by side. On 1.5 - 3 ton models, the standard location for the compressor is on the right. On 3.5 - 5 ton models, the standard location for the compressor is on the left side, 6 ton models are in the center.

➤ **Desert Duty Package**

To prevent sand and dust infiltration, the electrical control box is sealed.

➤ **Anti-Microbial Light**

A factory installed UV lamp to help improve indoor air quality.

➤ **Cold Plasma Air Purification Device**

A factory installed device to help improve indoor air quality.

Dry Contacts Alarm Outputs

 A dry contact is provided for each HVAC unit to indicate HVAC unit failure to the shelter alarm block. Unit failure is defined as 1) a high pressure lockout or 2) a low pressure lockout.

Controls

► Electronic Control Board

The exclusive Printed Circuit Board (PCB) in Eubank air conditioners sets the standard for the industry in terms of flexibility, reliability, and performance. This UL certified component is engineered to optimize Heating, Cooling and Dehumidification operation while communicating valuable information to the end user.

Special Features Include:

- Improved HVAC System Reliability (Built In Sequence / Timer Functionality And Simplified Wiring)
- On Board Configuration Menu With Adjustments Of Various Functions and Setpoints
- 2-Stage Compressor Operation
- Independent Indoor Blower Speed Adjustments For 1st Stage Cooling, 2nd Stage Cooling, Electric Heat And Dehumidification (Optimize Latent and Sensible Capacity)
- Built-In Remote Communication (Monitor and Control Via MODBUS Qty. 2 RJ11 Ports)
- Alarm Status and Fault Display(Drastically Reduces Troubleshooting Time and System Downtime)
- Thermocouple Thermistor To Monitor Refrigerant Temperature Of The Low Pressure Circuit and Liquid Line Circuit
- Economizer Control With Adjustments For Both Enthalpy Or Dry Bulb Sensor
- Economizer Status Output Contacts
- Emergency Ventilation Control (Systems Equipped with Ventilation Package)
- Forced Cooling (Overrides Economizer Operation)
- Dehumidification Control (Systems Equipped With Electric Reheat Or Hot Gas Reheat Dehumidification)
- Lockout Contacts (Normally Open Or Normally Closed)
- Alarms Communicated Via MODBUS

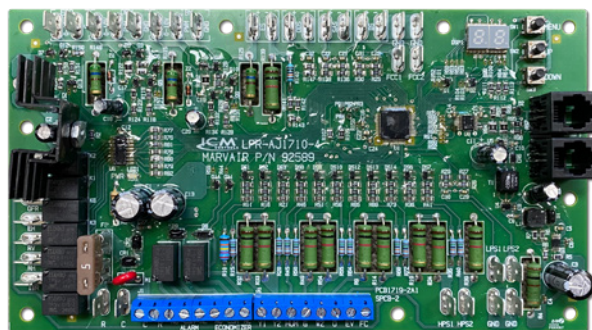

► Ambient Temperature Operating Ranges

Basic Model	Special Option	TEMPERATURE RANGES
Non-Economizer	Base Unit/Desert Duty	0°F - 131°F (-18°C - 55°C)
Economizer-Equipped	Base Unit/Desert Duty	-40°F - 131°F (-40°C - 55°C)

► SCFM @ Various External Static Pressures

Model Number	IWG Static Pressure						
	0.10	0.15	0.20	0.25	0.30	0.40	0.50
EAH1020A	760	745	730	685	640	560	
EAH1024A/EAH2024A	850	800	750	700	650	550	450
EAH1030A/EAH2030A	1120	1070	1020	970	920	820	720
EAH1036A/EAH2036A	1250	1200	1150	1100	1050	950	850
EAH1042A/EAH2042A	1300	1250	1200	1150	1100	1000	900
EAH1048A/EAH2048A	1500	1450	1400	1350	1300	1200	1100
EAH1060A/EAH2060A	1850	1800	1750	1700	1650	1550	1450
EGH1072A/EGH2072A	2100	2050	2000	1950	1900	1800	1700

Values in bold are the minimum air flow.

Air flow ratings of 208-230 volt units are at 230v. Air flow ratings of 460 volt units are at 460 volts.

Operation of units at a voltage different from the rating point will affect air flow.

► Room Size Limitations

		EAH1020A	EAH1024A	EAH1030A	EAH1036A	EAH1042A	EAH1048A	EAH1060A	EGH1072A
Minimum Room Size (ft ²)	Top Supply	74.6	74.6	88.4	88.4	110.0	110.0	103.1	132.5
	Center Supply	146.4	146.4	173.4	173.4	215.8	215.8	202.3	260.1
Minimum Supply Height (ft)	Top Supply	6.9	6.9	6.9	6.9	6.9	6.9	6.9	6.9
	Center Supply	3.5	3.5	3.5	3.5	3.5	3.5	3.5	3.5
		EAH2024A	EAH2030A	EAH2036A	EAH2042A	EAH2048A	EAH2060A	EGH2072A	
Minimum Room Size (ft ²)	Top Supply		93.3	88.4	103.1	120.8	125.7	122.7	147.3
	Center Supply		183.1	173.4	202.3	237.0	246.7	240.9	289.0
Minimum Supply Height (ft)	Top Supply		6.9	6.9	6.9	6.9	6.9	6.9	6.9
	Center Supply		3.5	3.5	3.5	3.5	3.5	3.5	3.5

Model Identification

Example	E	A	H	1	0	3	6	A	D	0	5	0	C	+	+	+	+	1	E	A	+	C	3	1	+	+	+	+	+	+
Position	1	2	3	4	5	6	7	8	9	10	11	12	13	14	15	16	17	18	19	20	21	22	23	24	25	26	27	28	29	30

1	Unit Designation/Family	E = Eubank Wall Mount S = Stock Unit
2	Energy Efficiency Ratio (EER)	A = 11 G = 10
3	Refrigerant Type	H = R-454B
4	Compressor Type/Quantity	1 = Fixed Speed/Single 2 = 2-Stage/Single
5		020 = 20,000 042 = 42,000
6	Unit Capacity/Nominal Cooling (BTUH)	024 = 24,000 048 = 48,000 030 = 30,000 060 = 60,000 036 = 36,000 072 = 72,000
8	System Type	A = Air Conditioner
9	Power Supply (Volts-Hz-Phase)	A = 208/230-60-1 D = 460-60-3 C = 208/230-60-3 Z = 575-60-3
10		000 = No Heat 080 = 8KW 022 = 2.2KW 090 = 9KW
11	Heat Designation @ Rated Voltage	036 = 3.6KW 100 = 10KW 040 = 4KW 120 = 12KW 050 = 5KW 150 = 15KW 060 = 6KW
13	Ventilation Configuration	A = Solid Front Door C = Economizer D = Motorized Damper w/Pressure Relief E = Motorized Damper w/Pressure Relief & Independent Motorized Damper Control F = No Free Cooling, 100% Emergency Ventilation Only w/Independent Control H = GreenWheel® ERV N = Barometric Damper w/15% OSA T = Title 24 Compliant Economizer & Controls + = None \$ = Special
14	Dehumidification	G = Hot Gas Reheat R = Electric Reheat + = None \$ = Special
15	Controls	A = Power Fail Alarm w/Additional Lockouts C = 24V EMS Relay Kit H = Factory Installed PLC + = None \$ = Special
16	Operating Condition	D = Desert Duty F = Desert Duty w/Hard Start G = Desert Duty w/EFS H = Desert Duty w/Hard Start & EFS N = Hard Start P = Hard Start w/Low Ambient & CCH Q = Hard Start w/Low Ambient & Fan Cycle Control (FCC) R = Crank Case Heater (CCH) T = Hard Start w/EFS V = Hard Start w/Low Ambient & CCH & EFS Z = Low Ambient w/CCH & EFS 2 = Low Ambient w/FCC & EFS + = None \$ = Special

17	Indoor Air Quality Features	A = UV Light D = Dry Bulb Sensor E = Dry Bulb Sensor w/Dirty Filter G = Dirty Filter Sensor K = Bi-Polar Ionization V = Dry Bulb, Dirty Filter & Dust Sensor + = None \$ = Special
18	Air Flow	1 = Top Supply/Center Return (STD) 2 = Center Supply/Top Return 3 = Bottom Supply/Middle Return 6 = 3T3 w/Top Supply/Center Return 7 = 3T5 w/Top Supply/Center Return 9 = 4T3 D = 3T3 Center Supply/Top Return E = 3T5 Center Supply/Top Return \$ = Special
19	Compressor Location	C = Center - All 6 ton units & 5 ton Center Supply/Top Return D = Left Hand - All 3 1/2 to 5 ton units E = Right Hand - All 1 1/2 to 3 ton units
20	Filter Option	A = 2" Pleated (MERV 8, AC/HP-C) D = MERV 11 High Filtration Package E = MERV 13 High Filtration Package F = Filter Access Through Return Air Grille W = Aluminum Washable + = None \$ = Special
21	Corrosion Protection	A = Condenser Coil Only C = Evaporator Coil Only D = Both Coils Condenser & Evaporator E = All Coils Cond/Evap/Reheat F = Coat All G = Coastal Package & Evaporator Coil K = Coastal Package + = None \$ = Special
22	Engineering Revision Level	B2 C2 C3 D3
24	Cabinet Color	1 = Marvair Beige (STD) 2 = Gray (STD) 3 = Carlsbad Canyon (STD) 4 = White (STD) 5 = Stainless Steel Exterior A = Stainless Steel - Unit \$ = Custom Color
25	Sound Attenuation	2 = Compressor Blanket + = None
26	Security Option	A = Lockable Access Plate/Tamper Proof + = None \$ = Special
27	Fastener/Drain Pan Option	A = Stainless Steel Fasteners C = Stainless Steel Drain Pan D = Stainless Steel Fasteners & Drain Pan + = None \$ = Special
28	Unused	+ = None \$ = Special
29	Unused	+ = None \$ = Special
30	Special Variation	+ = None \$ = Special Configuration Not Covered by Model Nomenclature

Note: Not all options are available with all configurations. Contact your Eubank sales representative for configuration details and feature compatibility.

GreenWheel® Energy Recovery Ventilator Performance

SCFM* of Outside Air	Energy Conserved, BTUH					
	95° DB/73° WB Outside • 80° DB/67° WB Inside			95° DB/80° WB Outside • 80° DB/67° WB Inside		
	Sensible	Latent	Total	Sensible	Latent	Total
225	2,900	1,100	4,000	2,900	6,400	9,300
250	3,100	1,200	4,300	3,100	6,900	10,000
325	3,700	1,400	5,100	3,700	8,100	11,800
400	4,200	1,500	5,700	4,200	9,100	13,300
450	4,500	1,600	6,100	4,500	9,700	14,200

SCFM* of Outside Air	Energy Conserved, BTUH								
	90° DB/74° WB Outside • 75° DB/64° WB Inside			80° DB/70° WB Outside • 75° DB/64° WB Inside			60° DB/54° WB Outside • 70° DB/58° WB Inside		
	Sensible	Latent	Total	Sensible	Latent	Total	Sensible	Latent	Total
225	2800	3600	6400	900	2800	2700	1900	200	2100
250	3000	3800	6800	1000	3000	4000	2000	200	2200
325	3600	4500	8100	1200	3500	4700	2400	200	2600
400	4100	4900	9000	1400	3800	5200	2700	300	3000
450	4300	5200	9500	1400	4000	5400	2900	300	3200

SCFM* of Outside Air	Energy Conserved, BTUH								
	40° DB/36° WB Outside • 70° DB/58° WB Inside			20° DB/18° WB Outside • 70° DB/58° WB Inside			0° DB/7° WB Outside • 70° DB/58° WB Inside		
	Sensible	Latent	Total	Sensible	Latent	Total	Sensible	Latent	Total
225	5600	3300	8900	9300	4900	14200	13000	5700	18700
250	6000	3600	9600	10000	5300	15300	14000	6100	14100
325	7200	4200	11400	12000	6200	18200	16700	7100	23800
400	8100	4600	12700	13500	6800	20300	18900	7900	26800
450	8600	4800	13400	14400	7100	21500	20100	8200	28300

*SCFM = Standard Cubic Feet per Minute

For performance of the GreenWheel® ERV at conditions other than those shown, please contact your Eubank® representative or the factory.

Eubank Single Stage Wall Mount Air Conditioner Performance Data

Efficiency and Capacity Ratings at ANSI/AHRI Standard 390 - EAH Air Conditioners with Single Stage Compressor



Model Number	EAH1020A	EAH1024A				EAH1030A				EAH1036A				EAH1042A				EAH1048A				EAH1060A				EGH1072A						
	A	A	C	D	Z	A	C	D	Z	A	C	D	Z	A	C	D	Z	A	C	D	Z	A	C	D	Z	A	C	D	Z	A	C	D
Cooling BTUH ¹	20,000	24,000				29,000				35,000				41,000				45,000				54,600				70,000						
EER ²	11.00	11.00				11.00				11.00				11.50				11.00				11.00				10.00						
Rated Air Flow (CFM ³)	760	850				1,070				1,200				1,250				1,400				1,750				2,000						

¹Cooling rated at 95°F (35°C) outdoor and 80°F DB/67° WB (26.5°C DB/19.5°C WB) return air ²EER=Energy Efficiency Ratio
³CFM=Cubic Feet per Minute
Ratings are with no outside air. Performance will be affected by altitude.
Ratings are at 230 volts for 208/230 volt units (“A” & “C” models) and 460 volts for “D” models. Operation of units at a different voltage from that of the rating point will affect performance and air flow.

Sensible Total Heat Ratio @ 95°F (35°C) Outside Air Dry Bulb - EAH Air Conditioners with Single Stage Compressor

Model Number	EAH1020A	EAH1024A				EAH1030A				EAH1036A				EAH1042A				EAH1048A				EAH1060A				EGH1072A						
	A	A	C	D	Z	A	C	D	Z	A	C	D	Z	A	C	D	Z	A	C	D	Z	A	C	D	Z	A	C	D	Z	A	C	D
Total Capacity	20,000	24,000				29,000				35,000				41,000				45,000				54,600				70,000						
Sensible Heat Ratio	0.78	0.74				0.76				0.71				0.71				0.71				0.71				0.65						
Sensible Capacity	15,600	17,700				22,000				25,000				29,000				32,100				39,000				45,700						
Rated Air Flow (CFM ¹)	760	850				1,070				1,200				1,250				1,400				1,750				2,000						

¹CFM=Cubic Feet per Minute
Sensible heat ratios based upon ANSI/AHRI std. 390 outdoor air conditions of 95°F (35°C) and 80°F DB/67° WB (26.5°C DB/19.5°C WB) return air.

Cooling Performance (BTUH) at Various Outdoor Temperatures

EAH Air Conditioners with Single Stage Compressor

Basic Model	Return Air DB/WB °F (°C)	Cooling Capacity BTUH	Outdoor Temperature											
			75°F (24°C)	80°F (27°C)	85°F (30°C)	90°F (32°C)	95°F (35°C)	100°F (38°C)	105°F (41°C)	110°F (43°C)	115°F (46°C)	120°F (49°C)	125°F (52°C)	130°F (54°C)
EAH1020A	72/61 (22/16)	Total	20,760	20,040	19,340	18,620	17,900	17,180	16,460	15,760	15,400	15,040	14,680	14,320
		Sensible	15,541	15,246	14,961	14,670	14,380	14,092	13,805	13,528	13,387	13,245	13,104	12,964
	76/63 (24/17)	Total	21,580	20,840	20,080	19,340	18,600	17,860	17,120	16,360	16,000	15,640	15,280	14,920
		Sensible	16,906	16,613	16,314	16,024	15,736	15,450	15,166	14,876	14,739	14,602	14,466	14,330
	80/67 (27/19)	Total	23,200	22,400	21,600	20,800	20,000	19,200	18,400	17,600	17,200	16,840	16,480	16,120
		Sensible	16,788	16,493	16,200	15,909	15,619	15,331	15,045	14,761	14,619	14,493	14,366	14,240
	84/71 (29/22)	Total	24,820	23,960	23,120	22,260	21,400	20,540	19,680	18,840	18,400	18,040	17,680	17,320
		Sensible	16,589	16,295	16,009	15,719	15,430	15,144	14,859	14,582	14,438	14,321	14,203	14,086
EAH1024A	72/61 (22/16)	Total	24,912	24,048	23,208	22,344	21,480	20,616	19,752	18,912	18,480	18,048	17,616	17,184
		Sensible	17,779	17,421	17,074	16,720	16,369	16,020	15,672	15,337	15,165	14,994	14,823	14,653
	76/63 (24/17)	Total	25,896	25,008	24,096	23,208	22,320	21,432	20,544	19,632	19,200	18,768	18,336	17,904
		Sensible	19,254	18,898	18,534	18,183	17,833	17,486	17,142	16,790	16,624	16,459	16,294	16,130
	80/67 (27/19)	Total	27,840	26,880	25,920	24,960	24,000	23,040	22,080	21,120	20,640	20,208	19,776	19,344
		Sensible	19,123	18,765	18,408	18,054	17,703	17,353	17,007	16,662	16,491	16,337	16,183	16,030
	84/71 (29/22)	Total	29,784	28,752	27,744	26,712	25,680	24,648	23,616	22,608	22,080	21,648	21,216	20,784
		Sensible	18,895	18,537	18,190	17,837	17,487	17,139	16,793	16,458	16,283	16,141	15,999	15,857
EAH1030A	72/61 (22/16)	Total	30,102	29,058	28,043	26,999	25,955	24,911	23,867	22,852	22,330	21,808	21,286	20,764
		Sensible	21,986	21,556	21,141	20,716	20,294	19,875	19,458	19,055	18,848	18,642	18,437	18,233
	76/63 (24/17)	Total	31,291	30,218	29,116	28,043	26,970	25,897	24,824	23,722	23,200	22,678	22,156	21,634
		Sensible	23,863	23,436	23,000	22,578	22,159	21,742	21,328	20,906	20,706	20,508	20,310	20,112
	80/67 (27/19)	Total	33,640	32,480	31,320	30,160	29,000	27,840	26,680	25,520	24,940	24,418	23,896	23,374
		Sensible	23,698	23,268	22,841	22,416	21,994	21,575	21,158	20,744	20,538	20,354	20,169	19,986
	84/71 (29/22)	Total	35,989	34,742	33,524	32,277	31,030	29,783	28,536	27,318	26,680	26,158	25,636	25,114
		Sensible	23,414	22,986	22,570	22,146	21,726	21,308	20,893	20,491	20,281	20,110	19,939	19,769
EAH1036A	72/61 (22/16)	Total	36,330	35,070	33,845	32,585	31,325	30,065	28,805	27,580	26,950	26,320	25,690	25,060
		Sensible	25,227	24,702	24,194	23,675	23,159	22,647	22,138	21,647	21,395	21,145	20,895	20,646
	76/63 (24/17)	Total	37,765	36,470	35,140	33,845	32,550	31,255	29,960	28,630	28,000	27,370	26,740	26,110
		Sensible	27,247	26,725	26,192	25,676	25,164	24,655	24,150	23,634	23,391	23,149	22,908	22,667
	80/67 (27/19)	Total	40,600	39,200	37,800	36,400	35,000	33,600	32,200	30,800	30,100	29,470	28,840	28,210
		Sensible	27,064	26,537	26,015	25,495	24,980	24,468	23,959	23,454	23,203	22,978	22,753	22,529
	84/71 (29/22)	Total	43,435	41,930	40,460	38,955	37,450	35,945	34,440	32,970	32,200	31,570	30,940	30,310
		Sensible	26,738	26,213	25,703	25,186	24,672	24,161	23,655	23,163	22,907	22,699	22,490	22,283
EAH1042A	72/61 (22/16)	Total	42,558	41,082	39,647	38,171	36,695	35,219	33,743	32,308	31,570	30,832	30,094	29,356
		Sensible	29,390	28,759	28,151	27,530	26,913	26,301	25,693	25,107	24,807	24,508	24,211	23,914
	76/63 (24/17)	Total	44,239	42,722	41,164	39,647	38,130	36,613	35,096	33,538	32,800	32,062	31,324	30,586
		Sensible	31,708	31,081	30,442	29,824	29,211	28,603	27,999	27,384	27,094	26,805	26,518	26,231
	80/67 (27/19)	Total	47,560	45,920	44,280	42,640	41,000	39,360	37,720	36,080	35,260	34,522	33,784	33,046
		Sensible	31,522	30,890	30,262	29,640	29,022	28,410	27,802	27,198	26,899	26,630	26,362	26,095
	84/71 (29/22)	Total	50,881	49,118	47,396	45,633	43,870	42,107	40,344	38,622	37,720	36,982	36,244	35,506
		Sensible	31,169	30,537	29,926	29,305	28,689	28,078	27,472	26,884	26,579	26,329	26,081	25,833
EAH1048A	72/61 (22/16)	Total	46,710	45,090	43,515	41,895	40,275	38,655	37,035	35,460	34,650	33,840	33,030	32,220
		Sensible	32,342	31,653	30,988	30,308	29,634	28,965	28,300	27,659	27,331	27,004	26,678	26,354
	76/63 (24/17)	Total	48,555	46,890	45,180	43,515	41,850	40,185	38,520	36,810	36,000	35,190	34,380	33,570
		Sensible	34,905	34,220	33,521	32,846	32,176	31,511	30,851	30,178	29,861	29,545	29,230	28,916
	80/67 (27/19)	Total	52,200	50,400	48,600	46,800	45,000	43,200	41,400	39,600	38,700	37,890	37,080	36,270
		Sensible	34,696	34,005	33,319	32,639	31,964	31,294	30,629	29,970	29,642	29,348	29,054	28,762
	84/71 (29/22)	Total	55,845	53,910	52,020	50,085	48,150	46,215	44,280	42,390	41,400	40,590	39,780	38,970
		Sensible	34,303	33,613	32,945	32,266	31,593	30,925	30,262	29,620	29,285	29,013	28,741	28,470
EAH1060A	72/61 (22/16)	Total	56,675	54,709	52,798	50,833	48,867	46,901	44,936	43,025	42,042	41,059	40,076	39,094
		Sensible	39,386	38,555	37,753	36,934	36,120	35,312	34,510	33,735	33,339	32,944	32,551	32,158
	76/63 (24/17)	Total	58,913	56,893	54,818	52,798	50,778	48,758	46,738	44,663	43,680	42,697	41,714	40,732
		Sensible	42,530	41,703	40,861	40,047	39,238	38,435	37,638	36,826	36,443	36,061	35,681	35,302
	80/67 (27/19)	Total	63,336	61,152	58,968	56,784	54,600	52,416	50,232	48,048	46,956	45,973	44,990	44,008
		Sensible	42,266	41,433	40,606	39,786	38,972	38,163	37,361	36,564	36,168	35,813	35,459	35,107
	84/71 (29/22)	Total	67,759	65,411	63,118	60,770	58,422	56,074	53,726	51,433	50,232	49,249	48,266	47,284
		Sensible	41,779	40,948	40,143	39,324	38,512	37,706	36,907	36,131	35,728	35,399	35,070	34,743
EGH1072A	72/61 (22/16)	Total	72,660	70,140	67,690	65,170	62,650	60,130	57,610	55,160	53,900	52,640	51,380	50,120
		Sensible	46,977	45,885	44,831	43,756	42,690	41,632	40,583	39,570	39,053	38,537	38,024	37,512
	76/63 (24/17)	Total	75,530	72,940	70,280	67,690	65,100	62,510	59,920	57,260	56,000	54,740	53,480	52,220
		Sensible	50,330	49,244	48,137	47,068	46,008	44,956	43,913	42,851	42,351	41,852	41,356	40,861
	80/67 (27/19)	Total	81,200	78,400	75,600	72,800	70,000	67,200	64,400	61,600	60,200	58,940	57,680	56,420
		Sensible	50,040	48,943	47,856	46,778	45,709	44,650	43,599	42,557	42,039	41,575	41,112	40,652
	84/71 (29/22)	Total	86,870	83,860	80,920	77,910	74,900	71,890	68,880	65,940	64,400	63,140	61,880	60,620
		Sensible	49,462	48,367	47,306	46,230	45,164	44,107	43,059	42,044	41,515	41,085	40,656	40,229

Based upon ANSI/AHRI std. 390 return air conditions of 80°F DB/67°F WB (26.5°C DB/19.5°C WB) at various outdoor conditions

Electrical Characteristics - Compressor, Fan & Blower Motors - EAH Air Conditioners with Single Stage Compressor

Basic Model	Compressor				Outdoor Fan Motor				Indoor Blower Motor				Ventilation GreenWheel Amps		
	Type	Volts-Hz-Ph	RLA ¹	LRA ²	Volts-Hz-Ph	RPM ³	FLA ⁴	HP ⁵	Volts-Hz-Ph	RPM ³	FLA ⁴	HP ⁵	OAM ⁶	EXM ⁷	WD ⁸
EAH1020AA	Scroll	208/230-60-1	10.3	60.2	208/230-60-1	1200	3.5	1/3	208/230-60-1	1200	2.8	1/3			
EAH1024AA		208/230-60-1	11.9	67.8	208/230-60-1	1200	3.5	1/3	208/230-60-1	1200	2.8	1/3			
EAH1030AA		208/230-60-1	13.5	82.5	208/230-60-1	850	2.2	1/3	208/230-60-1	1200	4.1	1/2	1.0	1.0	0.2
EAH1030AA ⁹		208/230-60-1	12.7	75.6	208/230-60-1	850	2.2	1/3	208/230-60-1	1200	4.1	1/2	1.0	1.0	0.2
EAH1036AA		208/230-60-1	14.7	109.0	208/230-60-1	850	2.2	1/3	208/230-60-1	1050	4.1	1/2	1.0	1.0	0.2
EAH1036AA ⁹		208/230-60-1	16.7	93.5	208/230-60-1	850	2.2	1/3	208/230-60-1	1050	4.1	1/2	1.0	1.0	0.2
EAH1042AA		208/230-60-1	18.6	123.0	208/230-60-1	1200	5.3	1/2	208/230-60-1	1050	4.1	1/2	1.0	1.0	0.2
EAH1048AA		208/230-60-1	22.4	126.0	208/230-60-1	1200	5.3	1/2	208/230-60-1	1050	6.0	3/4	1.0	1.0	0.2
EAH1060AA ¹⁰		208/230-60-1	23.7	157.0	208/230-60-1	1200	5.3	1/2	208/230-60-1	1050	6.0	3/4	1.0	1.0	0.2
EAH1060AA ¹¹		208/230-60-1	23.7	157.0	208/230-60-1	825	2.8	1/2	208/230-60-1	1120	4.0	3/4	1.0	1.0	0.2
EGH1072AA		208/230-60-1	32.8	183.9	208/230-60-1	1080	3.3	1/2	208/230-60-1	1050	6.8	3/4	1.0	1.0	0.2
EAH1024AC		Scroll	208/230-60-3	8.3	67.7	208/230-60-1	1200	3.5	1/3	208/230-60-1	1200	2.8	1/3		
EAH1030AC	208/230-60-3		12.8	97.5	208/230-60-1	850	2.2	1/3	208/230-60-1	1200	4.1	1/2	1.0	1.0	0.2
EAH1036AC	208/230-60-3		12.2	102.8	208/230-60-1	850	2.2	1/3	208/230-60-1	1200	4.1	1/2	1.0	1.0	0.2
EAH1042AC	208/230-60-3		12.8	102.8	208/230-60-1	1200	5.3	1/2	208/230-60-1	1050	4.1	1/2	1.0	1.0	0.2
EAH1048AC	208/230-60-3		12.8	120.4	208/230-60-1	1200	5.3	1/2	208/230-60-1	1050	6.0	3/4	1.0	1.0	0.2
EAH1060AC ¹⁰	208/230-60-3		16.0	156.4	208/230-60-1	1200	5.3	1/2	208/230-60-1	1050	6.0	3/4	1.0	1.0	0.2
EAH1060AC ¹¹	208/230-60-3		16.0	156.4	208/230-60-1	825	2.8	1/2	208/230-60-1	1120	4.0	3/4	1.0	1.0	0.2
EGH1072AC	208/230-60-3		22.4	166.2	208/230-60-1	1080	3.3	1/2	208/230-60-1	1050	6.8	3/4	1.0	1.0	0.2
EAH1024AD	Scroll	460-60-3	5.1	38.1	208/230-60-1	1200	3.5	1/3	208/230-60-1	1200	2.8	1/3			
EAH1030AD		460-60-3	5.1	44.3	208/230-60-1	850	2.2	1/3	208/230-60-1	1200	4.3	1/2	1.0	1.0	0.2
EAH1036AD		460-60-3	5.8	50.0	208/230-60-1	1200	3.5	1/3	208/230-60-1	1200	4.3	1/2	1.0	1.0	0.2
EAH1042AD		460-60-3	5.8	50.0	208/230-60-1	1200	5.3	1/2	208/230-60-1	1050	4.1	1/2	1.0	1.0	0.2
EAH1048AD		460-60-3	6.0	49.4	208/230-60-1	1200	5.3	1/2	208/230-60-1	1050	6.0	3/4	1.0	1.0	0.2
EAH1060AD ¹⁰		460-60-3	7.1	69.0	208/230-60-1	1200	5.3	1/2	208/230-60-1	1050	6.0	3/4	1.0	1.0	0.2
EAH1060AD ¹¹		460-60-3	7.1	69.0	208/230-60-1	825	2.8	1/2	208/230-60-1	1120	4.0	3/4	1.0	1.0	0.2
EGH1072AD		460-60-3	8.8	74.6	208/230-60-1	1080	3.3	1/2	208/230-60-1	1050	6.8	3/4	1.0	1.0	0.2
EAH1024AZ	Scroll	575-60-3	3.8	27.7	208/230-60-1	1080	3.3	1/2	208/230-60-1	1050	6.8	3/4			
EAH1030AZ		575-60-3	4.5	27.1	208/230-60-1	850	2.2	1/3	208/230-60-1	1200	4.3	1/2	1.0	1.0	0.2
EAH1036AZ		575-60-3	4.5	41.0	208/230-60-1	850	2.2	1/3	208/230-60-1	1200	4.3	1/2	1.0	1.0	0.2
EAH1042AZ		575-60-3	5.1	41.0	208/230-60-1	1200	5.3	1/2	208/230-60-1	1050	4.1	1/2	1.0	1.0	0.2
EAH1048AZ		575-60-3	5.8	41.0	208/230-60-1	1200	5.3	1/2	208/230-60-1	1050	6.0	3/4	1.0	1.0	0.2
EAH1060AZ ¹⁰		575-60-3	6.4	47.8	208/230-60-1	1200	5.3	1/2	208/230-60-1	1050	6.0	3/4	1.0	1.0	0.2
EAH1060AZ ¹¹		575-60-3	6.4	47.8	208/230-60-1	825	2.8	1/2	208/230-60-1	1120	4.0	3/4	1.0	1.0	0.2
EGH1072AZ		575-60-3	7.2	54.0	208/230-60-1	1080	3.3	1/2	208/230-60-1	1050	6.8	3/4	1.0	1.0	0.2

¹RLA = Rated Load Amps

²LRA = Locked Rotor Amps

³Revolutions per Minute

⁴FLA = Full Load Amps

⁵HP = Horsepower

⁶OAM = Outside Air Mover

⁷EXM = Exhaust Air Mover

⁸WD = Wheel Drive Motor

⁹Engineering Revision "B"

¹⁰Top Supply/Center Return

¹¹Center Supply/Top Return

460 volt units will have a step down transformer for the 230 volt motors.

Summary Electrical Ratings (Wire and Circuit Breaker Sizing) - EAH Air Conditioners with Single stage Compressors & Ventilation Configurations:

A = Solid Front Door

C = Economizer

D = Motorized Damper w/Pressure Relief

E = Motorized Damper w/Pressure Relief & Independent Motorized Damper Control

F = No Free Cooling, 100% Emergency Ventilation Only w/Independent Control

N = Barometric Damper w/15% OSA

T = Title 24 Compliant Economizer & Controls

Electric Heat		000 = None	022 = 2.2 kW	036 = 3.6 kW	040 = 4 kW	050 = 5 kW	060 = 6 kW	080 = 8 kW	090 = 9 kW	100 = 10 kW	120 = 12 kW	150 = 15 kW									
Basic Model	Volts-Hz-Ph	SPPE ³		SPPE ³		SPPE ³		SPPE ³		SPPE ³		SPPE ³									
		MCA ¹	MFS ²	MCA ¹	MFS ²	MCA ¹	MFS ²	MCA ¹	MFS ²	MCA ¹	MFS ²	MCA ¹	MFS ²								
EAH1020AA	208/230-60-1	19.2	25			23.6	25	28.8	30	34.1	35	44.5	45			54.9	60				
EAH1024AA	208/230-60-1	21.2	30			23.6	30	28.8	30	34.1	35	44.5	45			54.9	60				
EAH1030AA	208/230-60-1	23.2	35			24.9	35	30.1	35	35.4	40	45.8	50			56.2	60	66.6	70	82.2	90
EAH1030AA - B	208/230-60-1	22.2	30													56.2	60	66.6	70	82.2	90
EAH1036AA	208/230-60-1	24.7	35			24.9	35	30.1	35	35.4	40	45.8	50			56.2	60	66.6	70	82.2	90
EAH1036AA - B	208/230-60-1	27.2	40													56.2	60	66.6	70	82.2	90
EAH1042AA	208/230-60-1	32.7	50					32.7	50	35.4	50	45.8	50			56.2	60	66.6	70	82.2	90
EAH1048AA	208/230-60-1	39.3	60					39.3	60	39.3	60	47.7	60			58.1	60	68.5	70	84.1	90
EAH1060AA ⁴	208/230-60-1	40.9	60					40.9	60	40.9	60	47.7	60			58.1	60	68.5	70	84.1	90
EAH1060AA ⁵	208/230-60-1	36.4	60					36.4	60	36.4	60	45.7	60			56.1	60	66.5	70	82.1	90
EGH1072AA	208/230-60-1	51.1	80					51.1	80	51.1	80	51.1	80			58.9	80	69.3	80	84.9	90
EAH1024AC	208/230-60-3	16.7	20							20.8	25			29.9	30			38.9	40		
EAH1030AC	208/230-60-3	22.3	35							22.3	35			31.2	35			40.2	45	49.2	50
EAH1036AC	208/230-60-3	21.6	30							22.1	30			31.2	35			40.2	45	49.2	50
EAH1042AC	208/230-60-3	25.4	35							25.4	35			31.2	35			40.2	45	49.2	50
EAH1048AC	208/230-60-3	27.3	40							27.3	40			33.1	40			42.1	45	51.1	60
EAH1060AC ⁴	208/230-60-3	31.3	45							31.3	45			33.1	45			42.1	45	51.1	60
EAH1060AC ⁵	208/230-60-3	26.8	40							26.8	40			31.1	40			40.1	45	49.1	50
EGH1072AC	208/230-60-3	38.1	60							38.1	60			38.1	60			42.9	60	51.9	60
EAH1024AD	460-60-3	9.5	15							10.4	15			14.9	15			19.4	20		
EAH1030AD	460-60-3	9.6	15							11.2	15			15.7	20			20.2	25	24.7	25
EAH1036AD	460-60-3	11.2	15							11.2	15			15.7	20			20.2	25	24.7	25
EAH1042AD	460-60-3	12.0	15							12.0	15			15.6	20			20.1	25	24.6	25
EAH1048AD	460-60-3	13.2	15							13.2	15			16.5	20			21.0	25	25.6	30
EAH1060AD ⁴	460-60-3	14.5	20							14.5	20			16.5	20			21.0	25	25.6	30
EAH1060AD ⁵	460-60-3	12.3	15							12.3	15			15.5	20			20.0	20	24.6	25
EGH1072AD	460-60-3	16.1	20							16.1	20			16.9	20			21.4	25	26.0	30
EAH1024AZ	575-60-3	8.8	15							10.3	15			14.0	15			17.8	20		
EAH1030AZ	575-60-3	8.2	15							9.3	15			13.0	15			16.8	20	20.5	25
EAH1036AZ	575-60-3	8.2	15							9.3	15			13.0	15			16.8	20	20.5	25
EAH1042AZ	575-60-3	10.1	15							10.1	15			12.9	15			16.7	20	20.5	25
EAH1048AZ	575-60-3	11.8	15							11.8	15			13.7	15			17.5	20	21.2	25
EAH1060AZ ⁴	575-60-3	12.5	15							12.5	15			13.7	15			17.5	20	21.2	25
EAH1060AZ ⁵	575-60-3	10.7	15							10.7	15			12.9	15			16.7	20	20.4	25
EGH1072AZ	575-60-3	13.0	20							13.0	20			14.0	20			17.8	20	21.5	25

¹MCA = Minimum Circuit Ampacity (Wiring Size Amps) ²MFS = Maximum Fuse or HACR Breaker Size ³SPPE = Single Point Power Entry
⁴Top Supply/Center Return ⁵Center Supply/Top Return
MCA & MFS are calculated at 240 volts on the "A" & "C" models. The 480 volts "D" models are calculated at 480 volts. This chart should only be used as a guideline for estimating conductor size and overcurrent protection. For the requirements of specific units, always refer to the data label on the unit.
1. MFS (Maximum Fuses Size) value listed is the maximum value as per UL 60335-2-40 calculations for MOCP (branch-circuit conductor sizes in this chart are based on this MOCP). The actual factory installed Overcurrent Protective Device (Circuit Breaker) in the models may be lower than the maximum UL 60335-2-40 allowable MOCP value, but still above the UL 60335-2-40 minimum calculated value or Minimum Circuit Ampacity (MCA) listed.
2. The end user shall size conductors based on the Single Point Power Entry (SPPE) - Minimum Circuit Ampacity. The service circuit breaker shall not be sized less than the minimum circuit ampacity associated to Single Point Power Entry value provided. The service circuit breaker shall also not be sized greater than the Maximum Fuse size associated to the Single Point Power Entry Value Provided.
3. While this electrical data is presented as a guide, it is important to electrically connect properly sized fuses and conductor wires in accordance with the National Electrical Code and all local codes

Summary Electrical Ratings (Wire and Circuit Breaker Sizing) - EAH Air Conditioners with Electric Reheat ("R") with Single stage Compressors and Ventilation Configurations:

A = Solid Front Door

C = Economizer

D = Motorized Damper w/Pressure Relief

E = Motorized Damper w/Pressure Relief & Independent Motorized Damper Control

F = No Free Cooling, 100% Emergency Ventilation Only w/Independent Control

N = Barometric Damper w/15% OSA

T = Title 24 Compliant Economizer & Controls

Electric Heat		000 = None		022 = 2.2 kW		036 = 3.6 kW		040 = 4 kW		050 = 5 kW		060 = 6 kW		080 = 8 kW		090 = 9 kW		100 = 10 kW		120 = 12 kW		150 = 15 kW	
Basic Model	Volts-Hz-Ph	SPPE ³		SPPE ³		SPPE ³		SPPE ³		SPPE ³		SPPE ³		SPPE ³		SPPE ³		SPPE ³		SPPE ³		SPPE ³	
		MCA ¹	MFS ²	MCA ¹	MFS ²	MCA ¹	MFS ²	MCA ¹	MFS ²	MCA ¹	MFS ²	MCA ¹	MFS ²	MCA ¹	MFS ²	MCA ¹	MFS ²	MCA ¹	MFS ²	MCA ¹	MFS ²	MCA ¹	MFS ²
EAH1020AA	208/230-60-1	19.2	25					40.0	45	45.2	50	50.4	60	60.8	70			71.3	80				
EAH1024AA	208/230-60-1	21.2	30					42.0	45	47.2	50	52.4	60	62.8	70			73.3	80				
EAH1030AA	208/230-60-1	23.2	35					44.0	50	49.2	50	54.4	60	64.8	70			75.3	80	85.7	90	101.3	110
EAH1030AA - B	208/230-60-1	22.2	30															74.3	80	84.7	90	100.3	110
EAH1036AA	208/230-60-1	24.7	35					45.5	50	50.7	60	55.9	60	66.3	70			76.8	80	87.2	90	102.8	110
EAH1036AA - B	208/230-60-1	27.2	40															79.3	80	89.7	90	105.3	110
EAH1042AA	208/230-60-1	32.7	50							58.7	70	63.9	70	74.3	80			84.7	90	95.2	100	110.8	125
EAH1048AA	208/230-60-1	39.3	60							65.3	80	70.6	80	81.0	90			91.4	100	101.8	110	117.4	125
EAH1060AA ⁴	208/230-60-1	40.9	60							67.0	80	72.2	80	82.6	90			93.0	100	103.4	110	119.1	125
EAH1060AA ⁵	208/230-60-1	36.4	60							62.5	80	67.7	80	78.1	90			88.5	100	98.9	110	114.6	125
EGH1072AA	208/230-60-1	51.1	80							77.1	100	82.4	100	92.8	110			103.2	125	113.6	125	129.2	150
EAH1024AC	208/230-60-3	16.7	20									34.7	35			43.7	45			52.8	60		
EAH1030AC	208/230-60-3	22.3	35									40.3	45			49.4	50			58.4	60	67.4	70
EAH1036AC	208/230-60-3	21.6	30									39.6	45			48.6	50			57.6	60	66.7	70
EAH1042AC	208/230-60-3	25.4	35									43.4	50			52.5	60			61.5	70	70.5	80
EAH1048AC	208/230-60-3	27.3	40									45.3	50			54.4	60			63.4	70	72.4	80
EAH1060AC ⁴	208/230-60-3	31.3	45									49.3	60			58.4	60			67.4	70	76.4	80
EAH1060AC ⁵	208/230-60-3	26.8	40									44.8	50			53.9	60			62.9	70	71.9	80
EGH1072AC	208/230-60-3	38.1	60									56.1	70			65.2	80			74.2	80	83.2	90
EAH1024AD	460-60-3	9.5	15									18.5	20			23.1	25			27.6	30		
EAH1030AD	460-60-3	9.6	15									18.6	20			23.2	25			27.7	30	32.2	35
EAH1036AD	460-60-3	11.2	15									20.2	25			24.7	25			29.2	30	33.7	35
EAH1042AD	460-60-3	12.0	15									21.0	25			25.5	30			30.0	30	34.5	35
EAH1048AD	460-60-3	13.2	15									22.2	25			26.7	30			31.2	35	35.7	40
EAH1060AD ⁴	460-60-3	14.5	20									23.5	25			28.1	30			32.6	35	37.1	40
EAH1060AD ⁵	460-60-3	12.3	15									21.3	25			25.8	30			30.3	35	34.8	35
EGH1072AD	460-60-3	16.1	20									25.1	30			29.6	35			34.1	35	38.6	40
EAH1024AZ	575-60-3	8.8	15									16.3	20			20.1	25			23.9	25		
EAH1030AZ	575-60-3	8.2	15									15.8	20			19.5	20			23.3	25	27.1	30
EAH1036AZ	575-60-3	8.2	15									15.8	20			19.5	20			23.3	25	27.1	30
EAH1042AZ	575-60-3	10.1	15									17.7	20			21.4	25			25.2	30	29.0	30
EAH1048AZ	575-60-3	11.8	15									19.3	20			23.1	25			26.8	30	30.6	35
EAH1060AZ ⁴	575-60-3	12.5	15									20.1	25			23.8	25			27.6	30	31.3	35
EAH1060AZ ⁵	575-60-3	10.7	15									18.3	20			22.0	25			25.8	30	29.5	30
EGH1072AZ	575-60-3	13.0	20									20.6	25			24.3	25			28.1	30	31.9	35

¹MCA = Minimum Circuit Ampacity (Wiring Size Amps) ²MFS = Maximum Fuse or HACR Breaker Size ³SPPE = Single Point Power Entry
⁴Top Supply/Center Return ⁵Center Supply/Top Return
MCA & MFS are calculated at 240 volts on the "A" & "C" models. The 480 volts "D" models are calculated at 480 volts. This chart should only be used as a guideline for estimating conductor size and overcurrent protection. For the requirements of specific units, always refer to the data label on the unit.
1. MFS (Maximum Fuses Size) value listed is the maximum value as per UL 60335-2-40 calculations for MOCP (branch-circuit conductor sizes in this chart are based on this MOCP). The actual factory installed Overcurrent Protective Device (Circuit Breaker) in the models may be lower than the maximum UL 60335-2-40 allowable MOCP value, but still above the UL 60335-2-40 minimum calculated value or Minimum Circuit Ampacity (MCA) listed.
2. The end user shall size conductors based on the Single Point Power Entry (SPPE) - Minimum Circuit Ampacity. The service circuit breaker shall not be sized less than the minimum circuit ampacity associated to Single Point Power Entry value provided. The service circuit breaker shall also not be sized greater than the Maximum Fuse size associated to the Single Point Power Entry Value Provided.
3. While this electrical data is presented as a guide, it is important to electrically connect properly sized fuses and conductor wires in accordance with the National Electrical Code and all local codes

Unit Load Amps - EAH Air Conditioners with with Single stage Compressors and Ventilation Configurations:

A = Solid Front Door

C = Economizer

D = Motorized Damper w/Pressure Relief

E = Motorized Damper w/Pressure Relief & Independent Motorized Damper Control

F = No Free Cooling, 100% Emergency Ventilation Only w/Independent Control

N = Barometric Damper w/15% OSA

T = Title 24 Compliant Economizer & Controls

Basic Model	Volts-Hz-Ph	Current Amps		LOAD OF RESISTIVE HEATING - ELEMENTS ONLY (AMPS) (1) ALL HEATING ELEMENTS ARE ON SEPARATE CIRCUITS (2) SHADED VALUES (12 & 15 KW) UTILIZE TWO CIRCUITS										TOTAL MAXIMUM HEATING AMPS INCLUDES AMPS FROM MOTOR(S) THAT ARE LOCATED ON AN ELECTRICAL CIRCUIT THAT DOES NOT HAVE HEATERS									
		AC ¹	IBM ²	2.2	3.6	4.0	5.0	6.0	8.0	9.0	10.0	12.0	15.0	2.2	3.6	4.0	5.0	6.0	8.0	9.0	10.0	12.0	15.0
EAH1020AA	208/230-60-1	16.6	2.8			16.7	20.8	25.0	33.3		41.7					19.5	23.6	27.8	36.1		44.5		
EAH1024AA	208/230-60-1	18.2	2.8			16.7	20.8	25.0	33.3		41.7					19.5	23.6	27.8	36.1		44.5		
EAH1030AA	208/230-60-1	19.8	4.1			16.7	20.8	25.0	33.3		41.7	50.0	62.5			20.8	24.9	29.1	37.4		45.8	54.1	66.6
EAH1030AA - B	208/230-60-1	19.0	4.1								41.7	50.0	62.5								45.8	54.1	66.6
EAH1036AA	208/230-60-1	21.0	4.1			16.7	20.8	25.0	33.3		41.7	50.0	62.5			20.8	24.9	29.1	37.4		45.8	54.1	66.6
EAH1036AA - B	208/230-60-1	23.0	4.1								41.7	50.0	62.5								45.8	54.1	66.6
EAH1042AA	208/230-60-1	28.0	4.1				20.8	25.0	33.3		41.7	50.0	62.5				24.9	29.1	37.4		45.8	54.1	66.6
EAH1048AA	208/230-60-1	33.7	6.0				20.8	25.0	33.3		41.7	50.0	62.5				26.8	31.0	39.3		47.7	56.0	68.5
EAH1060AA ³	208/230-60-1	35.0	6.0				20.8	25.0	33.3		41.7	50.0	62.5				26.8	31.0	39.3		47.7	56.0	68.5
EAH1060AA ⁴	208/230-60-1	30.5	4.0				20.8	25.0	33.3		41.7	50.0	62.5				24.8	29.0	37.3		45.7	54.0	66.5
EGH1072AA	208/230-60-1	42.9	6.8				20.8	25.0	33.3		41.7	50.0	62.5				27.6	31.8	40.1		48.5	56.8	69.3
EAH1024AC	208/230-60-3	14.6	2.8					14.4		21.7		28.9						17.2		24.5		31.7	
EAH1030AC	208/230-60-3	19.1	4.1					14.4		21.7		28.9	36.1					18.5		25.8		33.0	40.2
EAH1036AC	208/230-60-3	18.5	4.1					14.4		21.7		28.9	36.1					18.5		25.8		33.0	40.2
EAH1042AC	208/230-60-3	22.2	4.1					14.4		21.7		28.9	36.1					18.5		25.8		33.0	40.2
EAH1048AC	208/230-60-3	24.1	6.0					14.4		21.7		28.9	36.1					20.4		27.7		34.9	42.1
EAH1060AC ³	208/230-60-3	27.3	6.0					14.4		21.7		28.9	36.1					20.4		27.7		34.9	42.1
EAH1060AC ⁴	208/230-60-3	22.8	4.0					14.4		21.7		28.9	36.1					18.4		25.7		32.9	40.1
EGH1072AC	208/230-60-3	32.5	6.8					14.4		21.7		28.9	36.1					21.2		28.5		35.7	42.9
EAH1024AD	460-60-3	8.3	1.4					7.2		10.8		14.4						8.6		12.2		15.8	
EAH1030AD	460-60-3	8.4	2.2					7.2		10.8		14.4	18.0					9.4		13.0		16.6	20.2
EAH1036AD	460-60-3	9.7	2.2					7.2		10.8		14.4	18.0					9.4		13.0		16.6	20.2
EAH1042AD	460-60-3	10.5	2.1					7.2		10.8		14.4	18.0					9.3		12.9		16.5	20.1
EAH1048AD	460-60-3	11.7	3.0					7.2		10.8		14.4	18.0					10.2		13.8		17.4	21.0
EAH1060AD ³	460-60-3	12.8	3.0					7.2		10.8		14.4	18.0					10.2		13.8		17.4	21.0
EAH1060AD ⁴	460-60-3	10.5	2.0					7.2		10.8		14.4	18.0					9.2		12.8		16.4	20.0
EGH1072AD	460-60-3	13.9	3.4					7.2		10.8		14.4	18.0					10.6		14.2		17.8	21.4
EAH1024AZ	575-60-3	7.8	2.7					6.0		9.0		12.0						8.7		11.7		14.7	
EAH1030AZ	575-60-3	7.1	1.7					6.0		9.0		12.0	15.1					7.7		10.7		13.7	16.8
EAH1036AZ	575-60-3	7.1	1.7					6.0		9.0		12.0	15.1					7.7		10.7		13.7	16.8
EAH1042AZ	575-60-3	8.9	1.6					6.0		9.0		12.0	15.1					7.6		10.6		13.6	16.7
EAH1048AZ	575-60-3	10.3	2.4					6.0		9.0		12.0	15.1					8.4		11.4		14.4	17.5
EAH1060AZ ³	575-60-3	10.9	2.4					6.0		9.0		12.0	15.1					8.4		11.4		14.4	17.5
EAH1060AZ ⁴	575-60-3	9.1	1.6					6.0		9.0		12.0	15.1					7.6		10.6		13.6	16.7
EGH1072AZ	575-60-3	11.2	2.7					6.0		9.0		12.0	15.1					8.7		11.7		14.7	17.8

¹AC = Air Conditioner Unit Amps

²IBM = Indoor Blower Motor

³Top Supply/Center Return

⁴Center Supply/Top Return

Heating kW is rated at 240 volts on the ACA & ACC models. Derate heater output by 25% for operation at 208 volts. Heating kW is rated at 480 volts on the ACD models. Total heating and cooling amps includes all motors. Three phase models contain single phase motor loads. Loads are not equally balanced on each phase and values shown are maximum phase loads.

Eubank 2-Stage Wall Mount Air Conditioner Performance Data

Efficiency and Capacity Ratings at ANSI/AHRI Standard 390 EAH Air Conditioners with 2-Stage Compressor



Model Number	EAH2024A	EAH2030A	EAH2036A	EAH2042A	EAH2048A	EAH2060A	EGH2072A
	A,C,D,Z	A,C,D,Z	A,C,D,Z	A,C,D,Z	A,C,D,Z	A,C,D,Z	A,C,D,Z
Cooling BTUH¹	20,600	29,000	33,000	40,000	46,000	54,000	66,000
EER²	11.00	11.00	11.00	11.00	11.00	11.00	10.00
Rated Air Flow (CFM³)	950	1,050	1,180	1,350	1,500	1,800	2,100

¹Cooling rated at 95°F (35°C) outdoor and 80°F DB/67° WB (26.5°C DB/19.5°C WB) return air ²EER=Energy Efficiency Ratio
³CFM=Cubic Feet per Minute
Ratings are with no outside air. Performance will be affected by altitude.
Ratings are at 230 volts for 208/230 volt units ("A" & "C" models) and 460 volts for "D" models. Operation of units at a different voltage from that of the rating point will affect performance and air flow.

Sensible Total Heat Ratio @ 95°F (35°C) Outside Air Dry Bulb - Air Conditioners with 2-Stage Compressor

Model Number	EAH2024A	EAH2030A	EAH2036A	EAH2042A	EAH2048A	EAH2060A	EGH2072A
	A,C,D,Z	A,C,D,Z	A,C,D,Z	A,C,D,Z	A,C,D,Z	A,C,D,Z	A,C,D,Z
Total Capacity	20,600	29,000	33,000	40,000	46,000	54,000	66,000
Sensible Heat Ratio	0.80	0.70	0.70	0.68	0.67	0.67	0.67
Sensible Capacity	16,500	20,300	23,100	27,200	31,000	36,500	42,000
Rated Air Flow (CFM¹)	950	1,050	1,180	1,350	1,500	1,800	2,100

¹CFM=Cubic Feet per Minute
Sensible heat ratios based upon ANSI/AHRI std. 390 outdoor air conditions of 95°F (35°C) and 80°F DB/67° WB (26.5°C DB/19.5°C WB) return air.

Cooling Performance (BTUH) at Various Outdoor Temperatures

EAH Air Conditioners with 2-Stage Compressor

MODEL	Return Air DB/WB °F(°C)	Outdoor Temperature												
		Cooling Capacity BTUH	75°F (24°C)	80°F (26.5°C)	85°F (29°C)	90°F (32°C)	95°F (35°C)	100°F (38°C)	105°F (40.5°C)	110°F (43.3°C)	115°F (46.1°C)	120°F (48.9°C)	125°F (51.7°C)	130°F (54.4°C)
EAH2024A	72/61 (22/16)	Total	21383	20641	19920	19179	18438	17695	16954	16233	15862	14317	13493	12699
		Sensible	16449	16154	15869	15576	15286	14996	14708	14429	14287	13695	13382	12699
	76/63 (24/17)	Total	22227	21465	20682	19920	19158	18396	17634	16851	16480	15038	14214	13390
		Sensible	17941	17648	17349	17059	16770	16483	16197	15905	15767	15038	14214	13390
	80/67 (27/19)	Total	23896	23072	22248	21424	20600	19776	18952	18128	17716	16480	15656	14832
		Sensible	17793	17498	17205	16913	16623	16335	16047	15762	15619	15194	14913	14633
	84/71 (29/22)	Total	25556	24679	23814	22928	22042	21156	20270	19405	18952	17922	17098	16274
		Sensible	17559	17265	16980	16690	16401	16114	15828	15550	15405	15078	14817	14557
EAH2030A	72/61 (22/16)	Total	30102	29058	28043	26999	25955	24911	23867	22852	22330	20155	18995	17835
		Sensible	20810	20379	19962	19536	19112	18692	18274	17869	17663	16807	16356	15907
	76/63 (24/17)	Total	31291	30218	29116	28043	26970	25897	24824	23722	23200	21170	20010	18850
		Sensible	22471	22043	21605	21182	20762	20344	19929	19505	19305	18534	18097	17663
	80/67 (27/19)	Total	33640	32480	30218	30160	29000	27840	26680	25520	24940	23200	22040	20880
		Sensible	22310	21878	23232	21023	20600	20180	19762	19347	19140	18525	18118	17713
	84/71 (29/22)	Total	35989	34742	33524	32277	31030	29783	28536	27318	26680	25230	24070	22910
		Sensible	22030	21599	21182	20757	20335	19916	19500	19097	18886	18411	18033	17657
EAH2036A	72/61 (22/16)	Total	34254	33066	31911	30723	29535	28347	27159	26004	25410	22935	21615	20295
		Sensible	23563	23071	22596	22110	21627	21147	20671	20210	19974	19000	18485	17974
	76/63 (24/17)	Total	35607	34386	33132	31911	30690	29469	28248	26994	26400	24090	22770	21450
		Sensible	25431	24942	24443	23961	23481	23005	22532	22048	21821	20942	20444	19950
	80/67 (27/19)	Total	38280	36960	35640	34320	33000	31680	30360	29040	28380	26400	25080	23760
		Sensible	25250	24757	24268	23782	23300	22820	22344	21871	21635	20934	20470	20009
	84/71 (29/22)	Total	40953	39534	38148	36729	35310	33891	32472	31086	30360	28710	27390	26070
		Sensible	24933	24442	23966	23482	23001	22523	22049	21588	21349	20806	20376	19948
EAH2042A	72/61 (22/16)	Total	41520	40080	38680	37240	35800	34360	32920	31520	30800	27800	26200	24600
		Sensible	27931	27328	26746	26151	25561	24974	24391	23828	23540	22350	21722	21098
	76/63 (24/17)	Total	43160	41680	40160	38680	37200	35720	34240	32720	33200	29200	27600	26000
		Sensible	30073	29474	28863	28272	27686	27103	26524	25933	23392	24581	23974	23370
	80/67 (27/19)	Total	46400	44800	43200	41600	40000	38400	36800	35200	34400	32000	30400	28800
		Sensible	29868	29264	28665	28070	27479	26892	26309	25731	25443	24586	24019	23456
	84/71 (29/22)	Total	49640	47920	46240	44520	42800	41080	39360	37680	36800	34800	33200	31600
		Sensible	29499	28897	28313	27719	27130	26546	25965	25402	25109	24446	23920	23397
EAH2048A	72/61 (22/16)	Total	47748	46092	44482	42826	41170	39514	37858	36248	35420	31970	30130	28290
		Sensible	31358	30660	29987	29299	28615	27937	27263	26612	26279	24904	24178	23458
	76/63 (24/17)	Total	49634	47932	46184	44482	42780	41078	39376	37628	36800	33580	31740	29900
		Sensible	33678	32984	32277	31593	30914	30240	29570	28887	28566	27325	26623	25926
	80/67 (27/19)	Total	53360	51520	49680	47840	46000	44160	42320	40480	39560	36800	34960	33120
		Sensible	33451	32752	32058	31369	30685	30006	29332	28663	28330	27339	26685	26035
	84/71 (29/22)	Total	57086	55108	53176	51198	49220	47242	45264	43332	42320	40020	38180	36340
		Sensible	33036	32339	31662	30975	30293	29617	28945	28294	27955	27189	26581	25977
EAH2060A	72/61 (22/16)	Total	56052	54108	52218	50274	48330	46386	44442	42552	41580	37530	35370	33210
		Sensible	37104	36289	35501	34697	33897	33104	32315	31554	31164	29555	28705	27862
	76/63 (24/17)	Total	58266	56268	54216	52218	50220	48222	46224	44172	43200	39420	37260	35100
		Sensible	39885	39074	38247	37448	36654	35865	35082	34283	33907	32455	31633	30818
	80/67 (27/19)	Total	62640	60480	58320	56160	54000	51840	49680	47520	46440	43200	41040	38880
		Sensible	39611	38794	37983	37178	36378	35585	34796	34014	33624	32465	31699	30938
	84/71 (29/22)	Total	67014	64692	62424	60102	57780	55458	53136	50868	49680	46980	44820	42660
		Sensible	39117	38302	37512	36709	35912	35121	34335	33754	33177	32281	31569	30862
EGH2072A	72/61 (22/16)	Total	68612	66232	63919	61539	59160	56780	54400	52087	50897	45940	43296	40652
		Sensible	49341	48333	47360	46366	45380	44400	43428	42489	42008	40025	38979	37941
	76/63 (24/17)	Total	71322	68876	66364	63919	61473	59027	56582	54070	52880	48263	45609	42965
		Sensible	53446	52443	51422	50434	49454	48481	47514	46529	46065	44275	43263	42259
	80/67 (27/19)	Total	76676	74032	71388	68744	66100	63456	60812	58168	56846	52880	50236	47592
		Sensible	53130	51120	51117	50122	49134	48154	47181	46216	45736	44306	43362	42425
	84/71 (29/22)	Total	82030	79188	76412	73569	70727	67885	65042	62266	60812	57507	54863	52219
		Sensible	52455	51536	50559	49566	48582	47604	46635	45695	45205	44100	43223	42352

Based upon ANSI/AHRI std. 390 return air conditions of 80°F DB/67° WB (26.5°C DB/19.5°C WB) at various outdoor temperatures.

Electrical Characteristics - Compressor, Fan & Blower Motors - EAH Air Conditioners with 2-Stage Compressor

Basic Model	Compressor				Outdoor Fan Motor				Indoor Blower Motor				Ventilation GreenWheel Amps		
	Type	Volts-Hz-Ph	RLA ¹	LRA ²	Volts-Hz-Ph	RPM ³	FLA ⁴	HP ⁵	Volts-Hz-Ph	RPM ³	FLA ⁴	HP ⁵	OAM ⁶	EXM ⁷	WD ⁸
EAH2024AA	Scroll	208/230-60-1	10.3	62.0	208/230-60-1	1200	3.5	1/3	208/230-60-1	1200	2.8	1/3			
EAH2030AA		208/230-60-1	14.6	90.0	208/230-60-1	850	2.2	1/3	208/230-60-1	1200	4.1	1/2	1.0	1.0	0.2
EAH2036AA		208/230-60-1	14.6	90.0	208/230-60-1	850	2.2	1/3	208/230-60-1	1050	4.1	1/2	1.0	1.0	0.2
EAH2042AA		208/230-60-1	TBD	TBD	208/230-60-1	1200	5.3	1/2	208/230-60-1	1050	4.1	1/2	1.0	1.0	0.2
EAH2048AA		208/230-60-1	18.3	138.0	208/230-60-1	1200	5.3	1/2	208/230-60-1	1050	6.0	3/4	1.0	1.0	0.2
EAH2060AA ⁹		208/230-60-1	25.2	147.3	208/230-60-1	1200	5.3	1/2	208/230-60-1	1050	6.0	3/4	1.0	1.0	0.2
EAH2060AA ¹⁰		208/230-60-1	25.2	147.3	208/230-60-1	825	2.8	1/2	208/230-60-1	1120	4.0	3/4	1.0	1.0	0.2
EGH2072AA		208/230-60-1	TBD	TBD	208/230-60-1	1080	3.3	1/2	208/230-60-1	1050	6.8	3/4	1.0	1.0	0.2
EAH2024AC	Scroll	208/230-60-3	TBD	TBD	208/230-60-1	1200	3.5	1/3	208/230-60-1	1200	2.8	1/3			
EAH2030AC		208/230-60-3	TBD	TBD	208/230-60-1	850	2.2	1/3	208/230-60-1	1200	4.1	1/2	1.0	1.0	0.2
EAH2036AC		208/230-60-3	TBD	TBD	208/230-60-1	850	2.2	1/3	208/230-60-1	1200	4.1	1/2	1.0	1.0	0.2
EAH2042AC		208/230-60-3	TBD	TBD	208/230-60-1	1200	5.3	1/2	208/230-60-1	1050	4.1	1/2	1.0	1.0	0.2
EAH2048AC		208/230-60-3	TBD	TBD	208/230-60-1	1200	5.3	1/2	208/230-60-1	1050	6.0	3/4	1.0	1.0	0.2
EAH2060AC ⁹		208/230-60-3	TBD	TBD	208/230-60-1	1200	5.3	1/2	208/230-60-1	1050	6.0	3/4	1.0	1.0	0.2
EAH2060AC ¹⁰		208/230-60-3	TBD	TBD	208/230-60-1	825	2.8	1/2	208/230-60-1	1120	4.0	3/4	1.0	1.0	0.2
EGH2072AC		208/230-60-3	23.2	142.0	208/230-60-1	1080	3.3	1/2	208/230-60-1	1050	6.8	3/4	1.0	1.0	0.2
EAH2024AD	Scroll	460-60-3	TBD	TBD	208/230-60-1	1200	3.5	1/3	208/230-60-1	1200	2.8	1/3			
EAH2030AD		460-60-3	TBD	TBD	208/230-60-1	850	2.2	1/3	208/230-60-1	1200	4.3	1/2	1.0	1.0	0.2
EAH2036AD		460-60-3	TBD	TBD	208/230-60-1	1200	3.5	1/3	208/230-60-1	1200	4.3	1/2	1.0	1.0	0.2
EAH2042AD		460-60-3	TBD	TBD	208/230-60-1	1200	5.3	1/2	208/230-60-1	1050	4.1	1/2	1.0	1.0	0.2
EAH2048AD		460-60-3	TBD	TBD	208/230-60-1	1200	5.3	1/2	208/230-60-1	1050	6.0	3/4	1.0	1.0	0.2
EAH2060AD ⁹		460-60-3	TBD	TBD	208/230-60-1	1200	5.3	1/2	208/230-60-1	1050	6.0	3/4	1.0	1.0	0.2
EAH2060AD ¹⁰		460-60-3	TBD	TBD	208/230-60-1	825	2.8	1/2	208/230-60-1	1120	4.0	3/4	1.0	1.0	0.2
EGH2072AD		460-60-3	9.5	73.1	208/230-60-1	1080	3.3	1/2	208/230-60-1	1050	6.8	3/4	1.0	1.0	0.2
EAH2030AZ	Scroll	575-60-3	TBD	TBD	208/230-60-1	850	2.2	1/3	208/230-60-1	1200	4.3	1/2	1.0	1.0	0.2
EAH2036AZ		575-60-3	TBD	TBD	208/230-60-1	850	2.2	1/3	208/230-60-1	1200	4.3	1/2	1.0	1.0	0.2
EAH2042AZ		575-60-3	TBD	TBD	208/230-60-1	1200	5.3	1/2	208/230-60-1	1050	4.1	1/2	1.0	1.0	0.2
EAH2048AZ		575-60-3	TBD	TBD	208/230-60-1	1200	5.3	1/2	208/230-60-1	1050	6.0	3/4	1.0	1.0	0.2
EAH2060AZ ⁹		575-60-3	TBD	TBD	208/230-60-1	1200	5.3	1/2	208/230-60-1	1050	6.0	3/4	1.0	1.0	0.2
EAH2060AZ ¹⁰		575-60-3	TBD	TBD	208/230-60-1	825	2.8	1/2	208/230-60-1	1120	4.0	3/4	1.0	1.0	0.2
EGH2072AZ		575-60-3	7.8	55.0	208/230-60-1	1080	3.3	1/2	208/230-60-1	1050	6.8	3/4	1.0	1.0	0.2

¹RLA = Rated Load Amps

²LRA = Locked Rotor Amps

³Revolutions per Minute

⁴FLA = Full Load Amps

⁵HP = Horsepower

⁶OAM = Outside Air Mover

⁷EXM = Exhaust Air Mover

⁸WD = Wheel Drive Motor

⁹Top Supply/Center Return

¹⁰Center Supply/Top Return

460 volt units will have a step down transformer for the 230 volt motors.

Summary Electrical Ratings (Wire and Circuit Breaker Sizing) - EAH Air Conditioners with 2-Stage Compressors & Ventilation Configurations:

A = Solid Front Door

C = Economizer

D = Motorized Damper w/Pressure Relief

E = Motorized Damper w/Pressure Relief & Independent Motorized Damper Control

F = No Free Cooling, 100% Emergency Ventilation Only w/Independent Control

N = Barometric Damper w/15% OSA

T = Title 24 Compliant Economizer & Controls

Electric Heat		0.0 kW	0.0 kW	4.0 kW	4.0 kW	5.0 kW	5.0 kW	6.0 kW	6.0 kW	8.0 kW	8.0 kW	9.0 kW	9.0 kW	10.0 kW	10.0 kW	12.0 kW	12.0 kW	15.0 kW	15.0 kW
Basic Model	Volts-Hz-Ph	SPPE ³		SPPE ³		SPPE ³		SPPE ³		SPPE ³		SPPE ³		SPPE ³		SPPE ³		SPPE ³	
		MCA ¹	MFS ²	MCA ¹	MFS ²	MCA ¹	MFS ²	MCA ¹	MFS ²	MCA ¹	MFS ²	MCA ¹	MFS ²	MCA ¹	MFS ²	MCA ¹	MFS ²	MCA ¹	MFS ²
EAH2024AA	208/230-60-1	19.2	25	23.6	25	28.8	30	34.1	35	44.5	45			54.9	60				
EAH2030AA	208/230-60-1	24.6	35	24.9	35	30.1	35	35.4	40	45.8	50			56.2	60	66.6	70	82.2	90
EAH2036AA	208/230-60-1	24.6	35	24.9	35	30.1	35	35.4	40	45.8	50			56.2	60	66.6	70	82.2	90
EAH2042AA	208/230-60-1	TBD	TBD	TBD	TBD	TBD	TBD	TBD	TBD	TBD	TBD			TBD	TBD	TBD	TBD	TBD	TBD
EAH2048AA	208/230-60-1	34.2	50	34.2	50	34.2	50	37.3	50	47.7	50			58.1	60	68.5	70	84.1	90
EAH2060AA ⁴	208/230-60-1	42.8	60	42.8	60	42.8	60	42.8	60	47.7	60			58.1	60	68.5	70	84.1	90
EAH2060AA ⁵	208/230-60-1	38.3	60	38.3	60	38.3	60	38.3	60	45.7	60			56.1	60	66.5	70	82.1	90
EGH2072AA	208/230-60-1	TBD	TBD	TBD	TBD	TBD	TBD	TBD	TBD	TBD	TBD			TBD	TBD	TBD	TBD	TBD	TBD
EAH2024AC	208/230-60-3	TBD	TBD					TBD	TBD			TBD	TBD			TBD	TBD	TBD	TBD
EAH2030AC	208/230-60-3	TBD	TBD					TBD	TBD			TBD	TBD			TBD	TBD	TBD	TBD
EAH2036AC	208/230-60-3	TBD	TBD					TBD	TBD			TBD	TBD			TBD	TBD	TBD	TBD
EAH2042AC	208/230-60-3	TBD	TBD					TBD	TBD			TBD	TBD			TBD	TBD	TBD	TBD
EAH2048AC	208/230-60-3	TBD	TBD					TBD	TBD			TBD	TBD			TBD	TBD	TBD	TBD
EAH2060AC ⁴	208/230-60-3	TBD	TBD					TBD	TBD			TBD	TBD			TBD	TBD	TBD	TBD
EAH2060AC ⁵	208/230-60-3	TBD	TBD					TBD	TBD			TBD	TBD			TBD	TBD	TBD	TBD
EGH2072AC	208/230-60-3	39.1	60					39.1	60			39.1	60			42.9	60	51.9	60
EAH2024AD	460-60-3	TBD	TBD					TBD	TBD			TBD	TBD			TBD	TBD	TBD	TBD
EAH2030AD	460-60-3	TBD	TBD					TBD	TBD			TBD	TBD			TBD	TBD	TBD	TBD
EAH2036AD	460-60-3	TBD	TBD					TBD	TBD			TBD	TBD			TBD	TBD	TBD	TBD
EAH2042AD	460-60-3	TBD	TBD					TBD	TBD			TBD	TBD			TBD	TBD	TBD	TBD
EAH2048AD	460-60-3	TBD	TBD					TBD	TBD			TBD	TBD			TBD	TBD	TBD	TBD
EAH2060AD ⁴	460-60-3	TBD	TBD					TBD	TBD			TBD	TBD			TBD	TBD	TBD	TBD
EAH2060AD ⁵	460-60-3	TBD	TBD					TBD	TBD			TBD	TBD			TBD	TBD	TBD	TBD
EGH2072AD	460-60-3	16.9	25					16.9	25			16.9	25			21.4	25	26.0	30
EAH2030AZ	575-60-3	TBD	TBD					TBD	TBD			TBD	TBD			TBD	TBD	TBD	TBD
EAH2036AZ	575-60-3	TBD	TBD					TBD	TBD			TBD	TBD			TBD	TBD	TBD	TBD
EAH2042AZ	575-60-3	TBD	TBD					TBD	TBD			TBD	TBD			TBD	TBD	TBD	TBD
EAH2048AZ	575-60-3	TBD	TBD					TBD	TBD			TBD	TBD			TBD	TBD	TBD	TBD
EAH2060AZ ⁴	575-60-3	TBD	TBD					TBD	TBD			TBD	TBD			TBD	TBD	TBD	TBD
EAH2060AZ ⁵	575-60-3	TBD	TBD					TBD	TBD			TBD	TBD			TBD	TBD	TBD	TBD
EGH2072AZ	575-60-3	13.8	20					13.8	20			14.0	20			17.8	20	21.5	25

¹MCA = Minimum Circuit Ampacity (Wiring Size Amps)

²MFS = Maximum Fuse or HACR Breaker Size

³SPPE = Single Point Power Entry

⁴Top Supply/Center Return

⁵Center Supply/Top Return

MCA & MFS are calculated at 240 volts on the "A" & "C" models. The 480 volts "D" models are calculated at 480 volts. This chart should only be used as a guideline for estimating conductor size and overcurrent protection. For the requirements of specific units, always refer to the data label on the unit.

1. MFS (Maximum Fuses Size) value listed is the maximum value as per UL 60335-2-40 calculations for MOCP (branch-circuit conductor sizes in this chart are based on this MOCP). The actual factory installed Overcurrent Protective Device (Circuit Breaker) in the models may be lower than the maximum UL 60335-2-40 allowable MOCP value, but still above the UL 60335-2-40 minimum calculated value or Minimum Circuit Ampacity (MCA) listed.
2. The end user shall size conductors based on the Single Point Power Entry (SPPE) - Minimum Circuit Ampacity. The service circuit breaker shall not be sized less than the minimum circuit ampacity associated to Single Point Power Entry value provided. The service circuit breaker shall also not be sized greater than the Maximum Fuse size associated to the Single Point Power Entry Value Provided.
3. While this electrical data is presented as a guide, it is important to electrically connect properly sized fuses and conductor wires in accordance with the National Electrical Code and all local codes

Summary Electrical Ratings (Wire and Circuit Breaker Sizing) - EAH Air Conditioners with Electric Reheat ("R") with 2-Stage Compressors and Ventilation Configurations:

A = Solid Front Door

C = Economizer

D = Motorized Damper w/Pressure Relief

E = Motorized Damper w/Pressure Relief & Independent Motorized Damper Control

F = No Free Cooling, 100% Emergency Ventilation Only w/Independent Control

N = Barometric Damper w/15% OSA

T = Title 24 Compliant Economizer & Controls

Electric Heat		0.0 kW	0.0 kW	4.0 kW	4.0 kW	5.0 kW	5.0 kW	6.0 kW	6.0 kW	8.0 kW	8.0 kW	9.0 kW	9.0 kW	10.0 kW	10.0 kW	12.0 kW	12.0 kW	15.0 kW	15.0 kW	
Basic Model	Volts-Hz-Ph	SPPE ³		SPPE ³		SPPE ³		SPPE ³		SPPE ³		SPPE ³		SPPE ³		SPPE ³		SPPE ³		
		MCA ¹	MFS ²	MCA ¹	MFS ²	MCA ¹	MFS ²	MCA ¹	MFS ²	MCA ¹	MFS ²	MCA ¹	MFS ²	MCA ¹	MFS ²	MCA ¹	MFS ²	MCA ¹	MFS ²	
EAH2024AA	208/230-60-1	19.2	25	40.0	45	45.2	50	50.4	60	60.8	70			71.3	80					
EAH2030AA	208/230-60-1	24.6	35	45.4	50	50.6	60	55.8	60	66.2	70			76.6	80	87.1	90	102.7	110	
EAH2036AA	208/230-60-1	24.6	35	45.4	50	50.6	60	55.8	60	66.2	70			76.6	80	87.1	90	102.7	110	
EAH2042AA	208/230-60-1	TBD	TBD	TBD	TBD	TBD	TBD	TBD	TBD	TBD	TBD			TBD	TBD	TBD	TBD	TBD	TBD	
EAH2048AA	208/230-60-1	34.2	50	55.0	60	60.2	70	65.4	70	75.8	80			86.3	90	96.7	100	112.3	125	
EAH2060AA ⁴	208/230-60-1	42.8	60	63.6	80	68.8	80	74.1	90	84.5	100			94.9	100	105.3	110	120.9	125	
EAH2060AA ⁵	208/230-60-1	38.3	60	59.1	80	64.3	80	69.6	80	80.0	90			90.4	100	100.8	110	116.4	125	
EGH2072AA	208/230-60-1	TBD	TBD	TBD	TBD	TBD	TBD	TBD	TBD	TBD	TBD			TBD	TBD	TBD	TBD	TBD	TBD	
EAH2024AC	208/230-60-3	TBD	TBD					TBD	TBD			TBD	TBD			TBD	TBD	TBD	TBD	
EAH2030AC	208/230-60-3	TBD	TBD					TBD	TBD			TBD	TBD			TBD	TBD	TBD	TBD	
EAH2036AC	208/230-60-3	TBD	TBD					TBD	TBD			TBD	TBD			TBD	TBD	TBD	TBD	
EAH2042AC	208/230-60-3	TBD	TBD					TBD	TBD			TBD	TBD			TBD	TBD	TBD	TBD	
EAH2048AC	208/230-60-3	TBD	TBD					TBD	TBD			TBD	TBD			TBD	TBD	TBD	TBD	
EAH2060AC ⁴	208/230-60-3	TBD	TBD					TBD	TBD			TBD	TBD			TBD	TBD	TBD	TBD	
EAH2060AC ⁵	208/230-60-3	TBD	TBD					TBD	TBD			TBD	TBD			TBD	TBD	TBD	TBD	
EGH2072AC	208/230-60-3	39.1	60					57.1	70			66.2	80			75.2	90	84.2	90	
EAH2024AD	460-60-3	TBD	TBD					TBD	TBD			TBD	TBD			TBD	TBD	TBD	TBD	
EAH2030AD	460-60-3	TBD	TBD					TBD	TBD			TBD	TBD			TBD	TBD	TBD	TBD	
EAH2036AD	460-60-3	TBD	TBD					TBD	TBD			TBD	TBD			TBD	TBD	TBD	TBD	
EAH2042AD	460-60-3	TBD	TBD					TBD	TBD			TBD	TBD			TBD	TBD	TBD	TBD	
EAH2048AD	460-60-3	TBD	TBD					TBD	TBD			TBD	TBD			TBD	TBD	TBD	TBD	
EAH2060AD ⁴	460-60-3	TBD	TBD					TBD	TBD			TBD	TBD			TBD	TBD	TBD	TBD	
EAH2060AD ⁵	460-60-3	TBD	TBD					TBD	TBD			TBD	TBD			TBD	TBD	TBD	TBD	
EGH2072AD	460-60-3	16.9	25					25.9	30			30.5	35			35.0	40	39.5	40	
EAH2030AZ	575-60-3	TBD	TBD					TBD	TBD			TBD	TBD			TBD	TBD	TBD	TBD	
EAH2036AZ	575-60-3	TBD	TBD					TBD	TBD			TBD	TBD			TBD	TBD	TBD	TBD	
EAH2042AZ	575-60-3	TBD	TBD					TBD	TBD			TBD	TBD			TBD	TBD	TBD	TBD	
EAH2048AZ	575-60-3	TBD	TBD					TBD	TBD			TBD	TBD			TBD	TBD	TBD	TBD	
EAH2060AZ ⁴	575-60-3	TBD	TBD					TBD	TBD			TBD	TBD			TBD	TBD	TBD	TBD	
EAH2060AZ ⁵	575-60-3	TBD	TBD					TBD	TBD			TBD	TBD			TBD	TBD	TBD	TBD	
EGH2072AZ	575-60-3	13.8	20					21.3	25			25.1	30			28.9	30	32.6	35	

¹MCA = Minimum Circuit Ampacity (Wiring Size Amps) ²MFS = Maximum Fuse or HACR Breaker Size ³SPPE = Single Point Power Entry
⁴Top Supply/Center Return ⁵Center Supply/Top Return
MCA & MFS are calculated at 240 volts on the "A" & "C" models. The 480 volts "D" models are calculated at 480 volts. This chart should only be used as a guideline for estimating conductor size and overcurrent protection. For the requirements of specific units, always refer to the data label on the unit.
1. MFS (Maximum Fuses Size) value listed is the maximum value as per UL 60335-2-40 calculations for MOCP (branch-circuit conductor sizes in this chart are based on this MOCP). The actual factory installed Overcurrent Protective Device (Circuit Breaker) in the models may be lower than the maximum UL 60335-2-40 allowable MOCP value, but still above the UL 60335-2-40 minimum calculated value or Minimum Circuit Ampacity (MCA) listed.
2. The end user shall size conductors based on the Single Point Power Entry (SPPE) - Minimum Circuit Ampacity. The service circuit breaker shall not be sized less than the minimum circuit ampacity associated to Single Point Power Entry value provided. The service circuit breaker shall also not be sized greater than the Maximum Fuse size associated to the Single Point Power Entry Value Provided.
3. While this electrical data is presented as a guide, it is important to electrically connect properly sized fuses and conductor wires in accordance with the National Electrical Code and all local codes

Unit Load Amps - EAH Air Conditioners with with 2-Stage Compressors and Ventilation Configurations:

A = Solid Front Door

C = Economizer

D = Motorized Damper w/Pressure Relief

E = Motorized Damper w/Pressure Relief & Independent Motorized Damper Control

F = No Free Cooling, 100% Emergency Ventilation Only w/Independent Control

N = Barometric Damper w/15% OSA

T = Title 24 Compliant Economizer & Controls

Basic Model	Volts-Hz-Ph	Current Amps		LOAD OF RESISTIVE HEATING - ELEMENTS ONLY (AMPS) (1) ALL HEATING ELEMENTS ARE ON A SEPARATE CIRCUIT (2) SHADED VALUES (12 & 15 kW) UTILIZE TWO CIRCUITS										TOTAL MAXIMUM HEATING AMPS INCLUDES AMPS FROM MOTOR(S) THAT ARE LOCATED ON AN ELECTRICAL CIRCUIT THAT DOES NOT HAVE HEATERS					
		AC ¹	IBM ²	4.0	5.0	6.0	8.0	9.0	10.0	12.0	15.0	4.0	5.0	6.0	8.0	9.0	10.0	12.0	15.0
EAH2024AA	208/230-60-1	16.6	2.8	16.7	20.8	25.0	33.3		41.7			19.5	23.6	27.8	36.1		44.5		
EAH2030AA	208/230-60-1	20.9	4.1	16.7	20.8	25.0	33.3		41.7	50.0	62.5	20.8	24.9	29.1	37.4		45.8	54.1	66.6
EAH2036AA	208/230-60-1	20.9	4.1	16.7	20.8	25.0	33.3		41.7	50.0	62.5	20.8	24.9	29.1	37.4		45.8	54.1	66.6
EAH2042AA	208/230-60-1	TBD	TBD	TBD	TBD	TBD	TBD		TBD	TBD	TBD	TBD	TBD	TBD	TBD		TBD	TBD	TBD
EAH2048AA	208/230-60-1	29.6	6.0	16.7	20.8	25.0	33.3		41.7	50.0	62.5	22.7	26.8	31.0	39.3		47.7	56.0	68.5
EAH2060AA ³	208/230-60-1	36.5	6.0	16.7	20.8	25.0	33.3		41.7	50.0	62.5	22.7	26.8	31.0	39.3		47.7	56.0	68.5
EAH2060AA ⁴	208/230-60-1	32.0	4.0	16.7	20.8	25.0	33.3		41.7	50.0	62.5	20.7	24.8	29.0	37.3		45.7	54.0	66.5
EGH2072AA	208/230-60-1	TBD	TBD	TBD	TBD	TBD	TBD		TBD	TBD	TBD	TBD	TBD	TBD	TBD		TBD	TBD	TBD
EAH2024AC	208/230-60-3	TBD	TBD			TBD		TBD		TBD	TBD			TBD		TBD		TBD	TBD
EAH2030AC	208/230-60-3	TBD	TBD			TBD		TBD		TBD	TBD			TBD		TBD		TBD	TBD
EAH2036AC	208/230-60-3	TBD	TBD			TBD		TBD		TBD	TBD			TBD		TBD		TBD	TBD
EAH2042AC	208/230-60-3	TBD	TBD			TBD		TBD		TBD	TBD			TBD		TBD		TBD	TBD
EAH2048AC	208/230-60-3	TBD	TBD			TBD		TBD		TBD	TBD			TBD		TBD		TBD	TBD
EAH2060AC ³	208/230-60-3	TBD	TBD			TBD		TBD		TBD	TBD			TBD		TBD		TBD	TBD
EAH2060AC ⁴	208/230-60-3	TBD	TBD			TBD		TBD		TBD	TBD			TBD		TBD		TBD	TBD
EGH2072AC	208/230-60-3	33.3	6.8			14.4		21.7		28.9	36.1			21.2		28.5		35.7	42.9
EAH2024AD	460-60-3	TBD	TBD			TBD		TBD		TBD	TBD			TBD		TBD		TBD	TBD
EAH2030AD	460-60-3	TBD	TBD			TBD		TBD		TBD	TBD			TBD		TBD		TBD	TBD
EAH2036AD	460-60-3	TBD	TBD			TBD		TBD		TBD	TBD			TBD		TBD		TBD	TBD
EAH2042AD	460-60-3	TBD	TBD			TBD		TBD		TBD	TBD			TBD		TBD		TBD	TBD
EAH2048AD	460-60-3	TBD	TBD			TBD		TBD		TBD	TBD			TBD		TBD		TBD	TBD
EAH2060AD ³	460-60-3	TBD	TBD			TBD		TBD		TBD	TBD			TBD		TBD		TBD	TBD
EAH2060AD ⁴	460-60-3	TBD	TBD			TBD		TBD		TBD	TBD			TBD		TBD		TBD	TBD
EGH2072AD	460-60-3	14.6	3.4			7.2		10.8		14.4	18.0			10.6		14.2		17.8	21.4
EAH2030AZ	575-60-3	TBD	TBD			TBD		TBD		TBD	TBD			TBD		TBD		TBD	TBD
EAH2036AZ	575-60-3	TBD	TBD			TBD		TBD		TBD	TBD			TBD		TBD		TBD	TBD
EAH2042AZ	575-60-3	TBD	TBD			TBD		TBD		TBD	TBD			TBD		TBD		TBD	TBD
EAH2048AZ	575-60-3	TBD	TBD			TBD		TBD		TBD	TBD			TBD		TBD		TBD	TBD
EAH2060AZ ³	575-60-3	TBD	TBD			TBD		TBD		TBD	TBD			TBD		TBD		TBD	TBD
EAH2060AZ ⁴	575-60-3	TBD	TBD			TBD		TBD		TBD	TBD			TBD		TBD		TBD	TBD
EGH2072AZ	575-60-3	11.8	2.7			6.0		9.0		12.0	15.1			8.7		11.7		14.7	17.8

¹AC = Air Conditioner Unit Amps ²IBM = Indoor Blower Motor

³Top Supply/Center Return ⁴Center Supply/Top Return

Heating kW is rated at 240 volts on the A & C models. Derate heater output by 25% for operation at 208 volts. Heating kW is rated at 480 volts on the D models.

Total heating and cooling amps includes all motors. Three phase models contain single phase motor loads. Loads are not equally balanced on each phase and values shown are maximum phase loads.

Dimensional Data - EAH1020A, EAH1024A & EAH2024A

Engineering Revision "C"

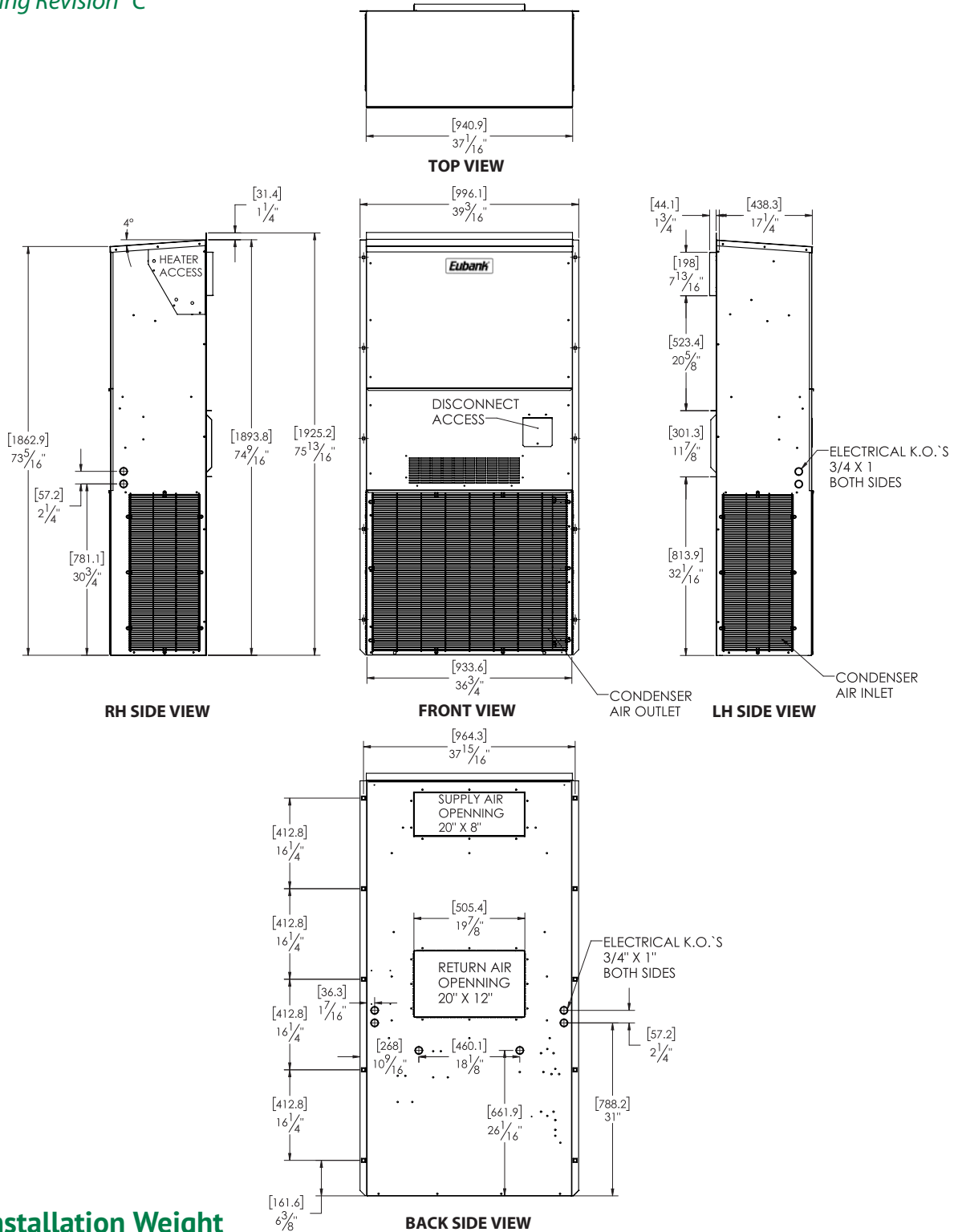

Installation Weight

EAH1020A & EAH1024A	Base	w/Economizer	w/3 Phase	w/Economizer & 3 Phase
Pounds	337	357	356	376
Kilograms	153	162	161	171

Filter Size

EAH1020A & EAH1024A	INCHES	MILLIMETERS	PART NUMBER	FILTERS PER UNIT	MERV RATING
RETURN AIR FILTER	16 x 25 x 2	406 x 635 x 51	80137	1	8

Note: All overall outside dimensions are given with +/- .250" (6mm) tolerance.

Dimensional Data - EAH1030A, EAH1036A & EAH2030A, EAH2036A

Engineering Revision "C"

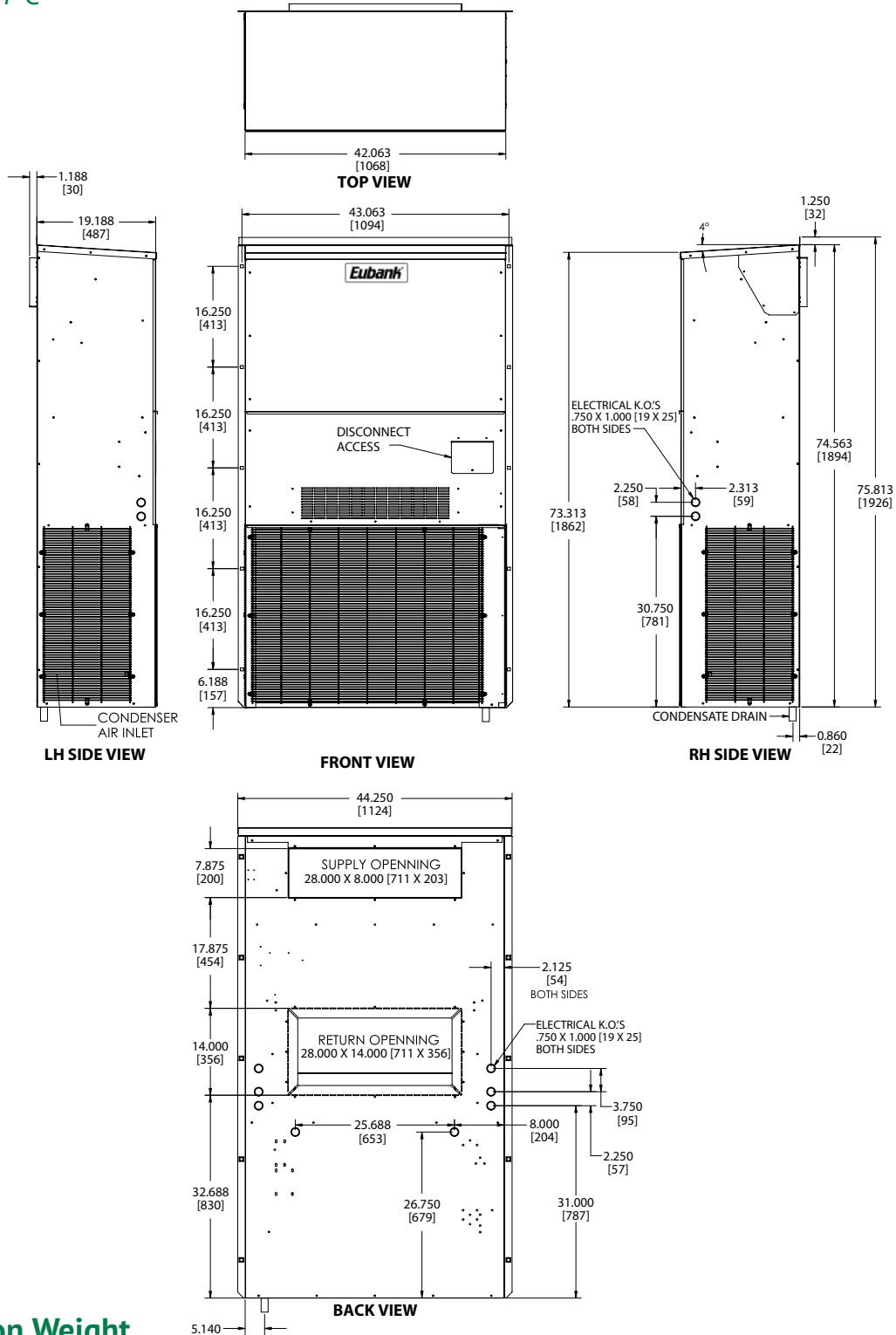

Installation Weight

	EAH1030A & EAH1036A	Base	w/Economizer	w/3 Phase	w/Economizer & 3 Phase
Pounds		397	419	416	438
Kilograms		180	190	189	199

Filter Size

	EAH1030A & EAH1036A	INCHES	MILLIMETERS	PART NUMBER	FILTERS PER UNIT	MERV RATING
RETURN AIR FILTER		18 x 30 x 2	457 x 762 x 51	93184	1	8

Note: All overall outside dimensions are given with +/- .250" (6mm) tolerance.

Dimensional Data - EAH1030A, EAH1036A

Engineering Revision "B"

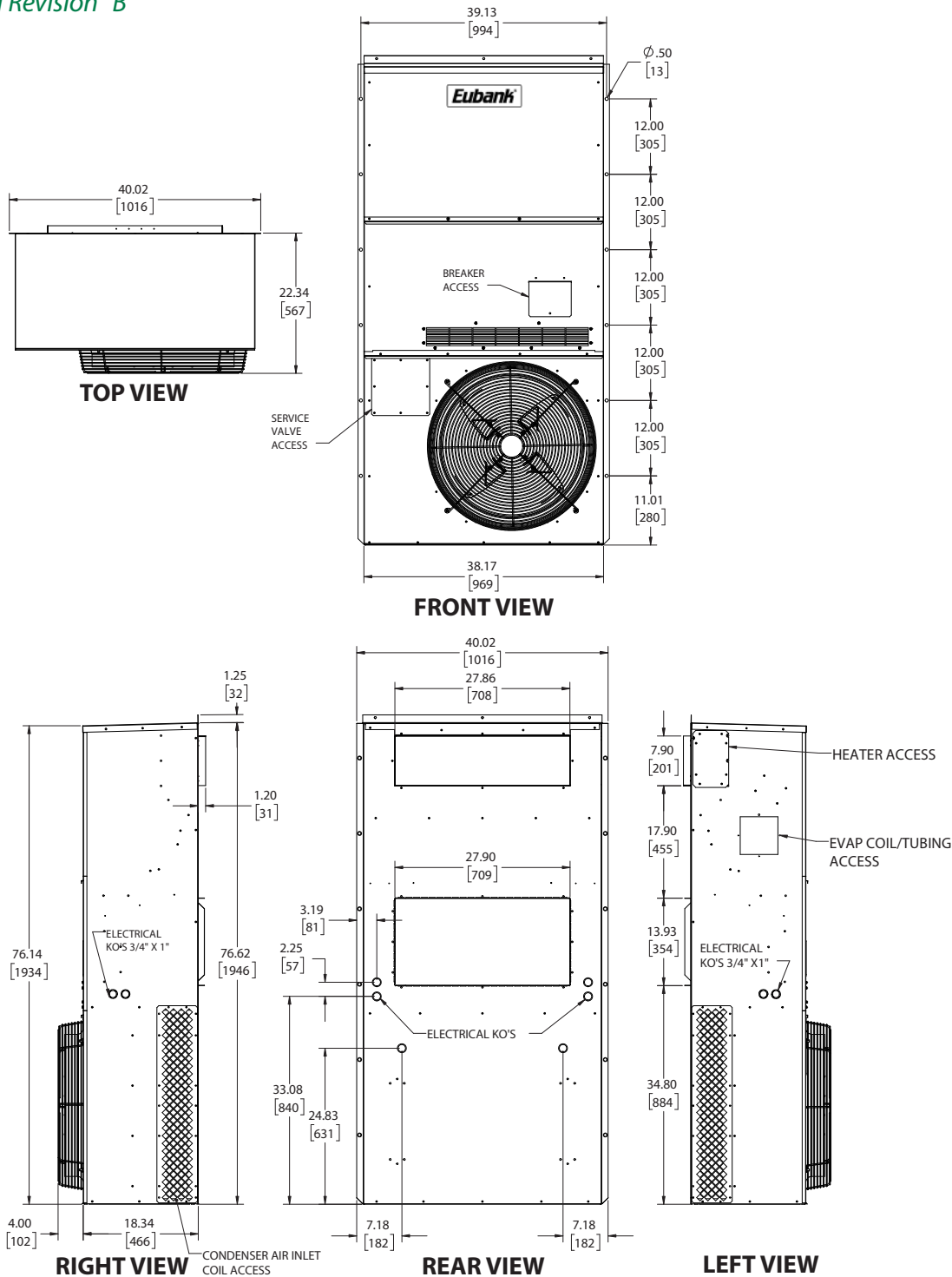

Installation Weight

EAH1030A "B", EAH1036A "B"	Base	w/Economizer	w/3 Phase	w/Economizer & 3 Phase
Pounds	380	403	418	441
Kilograms	172	183	190	200

Filter Size

EAH1030A "B", EAH1036A "B"	INCHES	MILLIMETERS	PART NUMBER	FILTERS PER UNIT	MERV RATING
INTERNAL¹	16 x 30 x 1	406 x 762 x 25	80136	1	N/A
RETURN GRILLE²	27½ x 13½ x 1	699 x 343 x 25	80769	1	N/A

¹Optional; Return grille filter is recommended. ²Recommended **Note:** All overall outside dimensions are given with +/- .250" (6mm) tolerance.

Dimensional Data - EAH1036A & EAH2036A - 3T3

Engineering Revision "D"

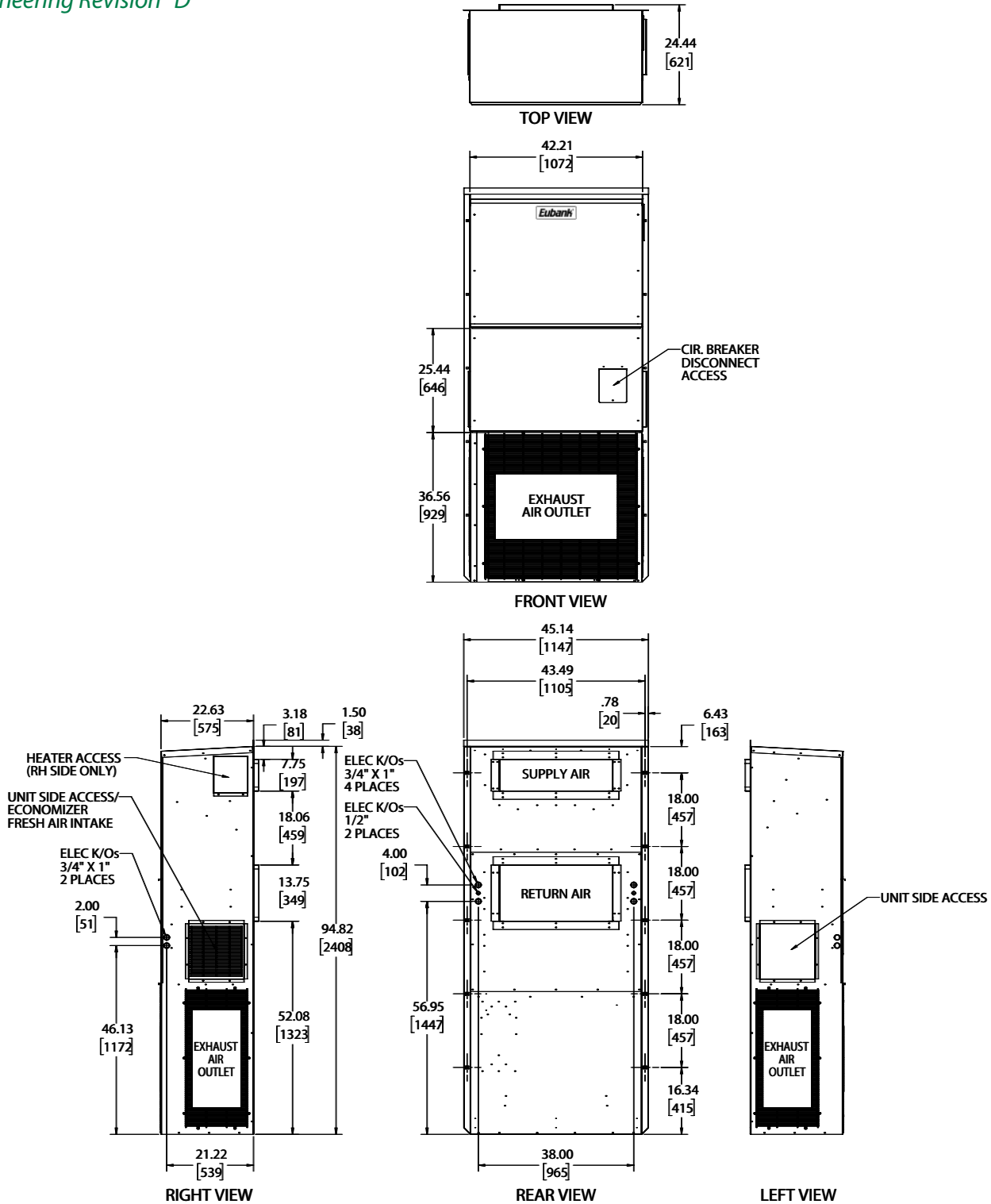

Installation Weight

EAH1036A & EAH2036A 3T3	Base	w/Economizer	w/3 Phase	w/Economizer & 3 Phase
Pounds	535	558	588	611
Kilograms	243	253	267	277

Filter Size

EAH1036A & EAH2036A 3T3	INCHES	MILLIMETERS	PART NUMBER	FILTERS PER UNIT	MERV RATING
RETURN AIR FILTER	15½ x 36½ x 2	394 x 927 x 51	92985	1	8

Note: All overall outside dimensions are given with +/- .250" (6mm) tolerance.

Dimensional Data - EAH1036A & EAH2036A - 3T5

Engineering Revision "D"

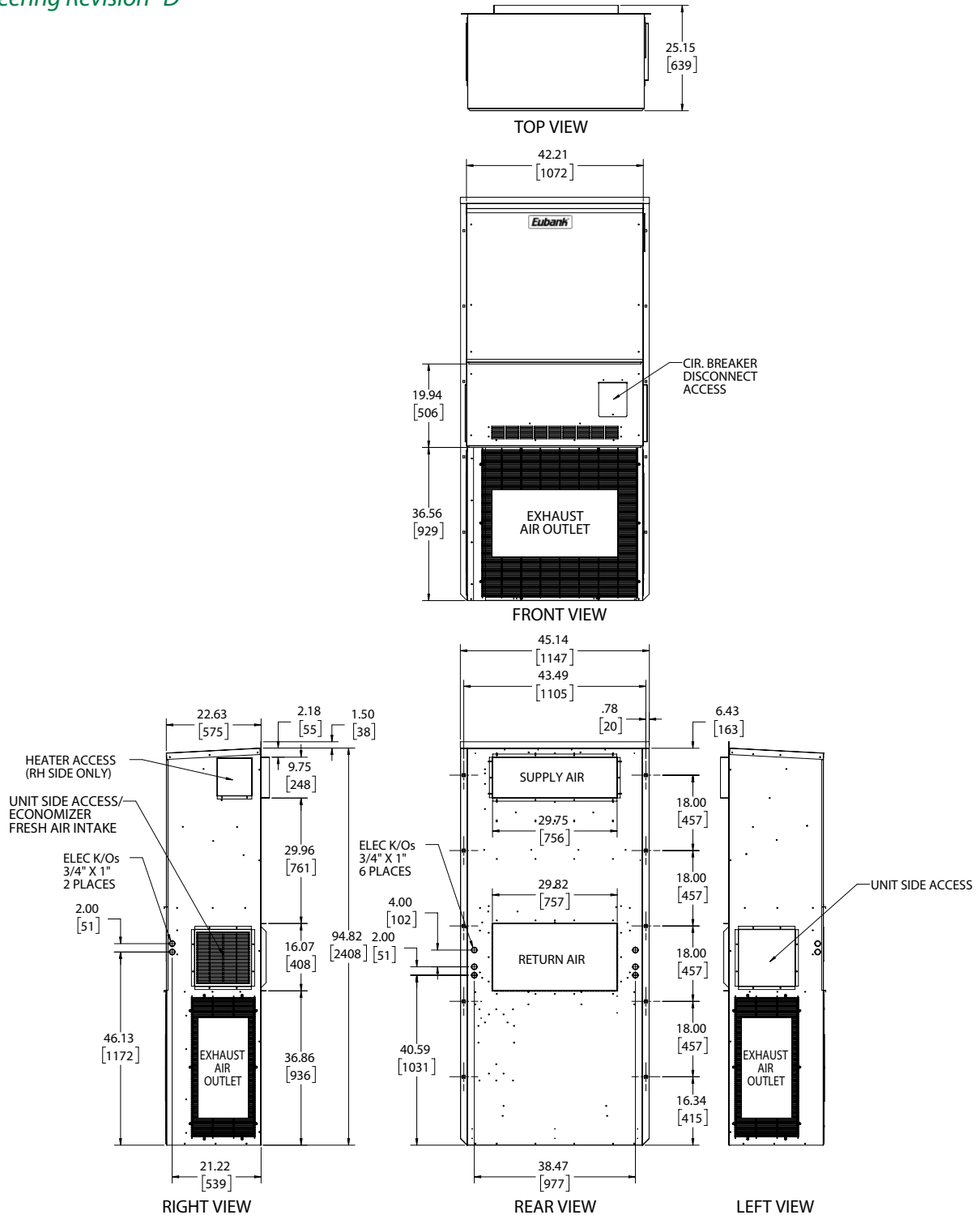

Installation Weight

EAH1036A & EAH2036A	Base	w/Economizer	w/3 Phase	w/Economizer & 3 Phase
Pounds	535	558	588	611
Kilograms	243	253	267	277

Filter Size

EAH1036A & EAH2036A	INCHES	MILLIMETERS	PART NUMBER	FILTERS PER UNIT	MERV RATING
RETURN AIR FILTER	15½ x 36½ x 2	394 x 927 x 51	92985	1	8

Note: All overall outside dimensions are given with +/- .250" (6mm) tolerance.

Dimensional Data - EAH1036A 3T3 Center Supply/Top Return

Engineering Revision "D"

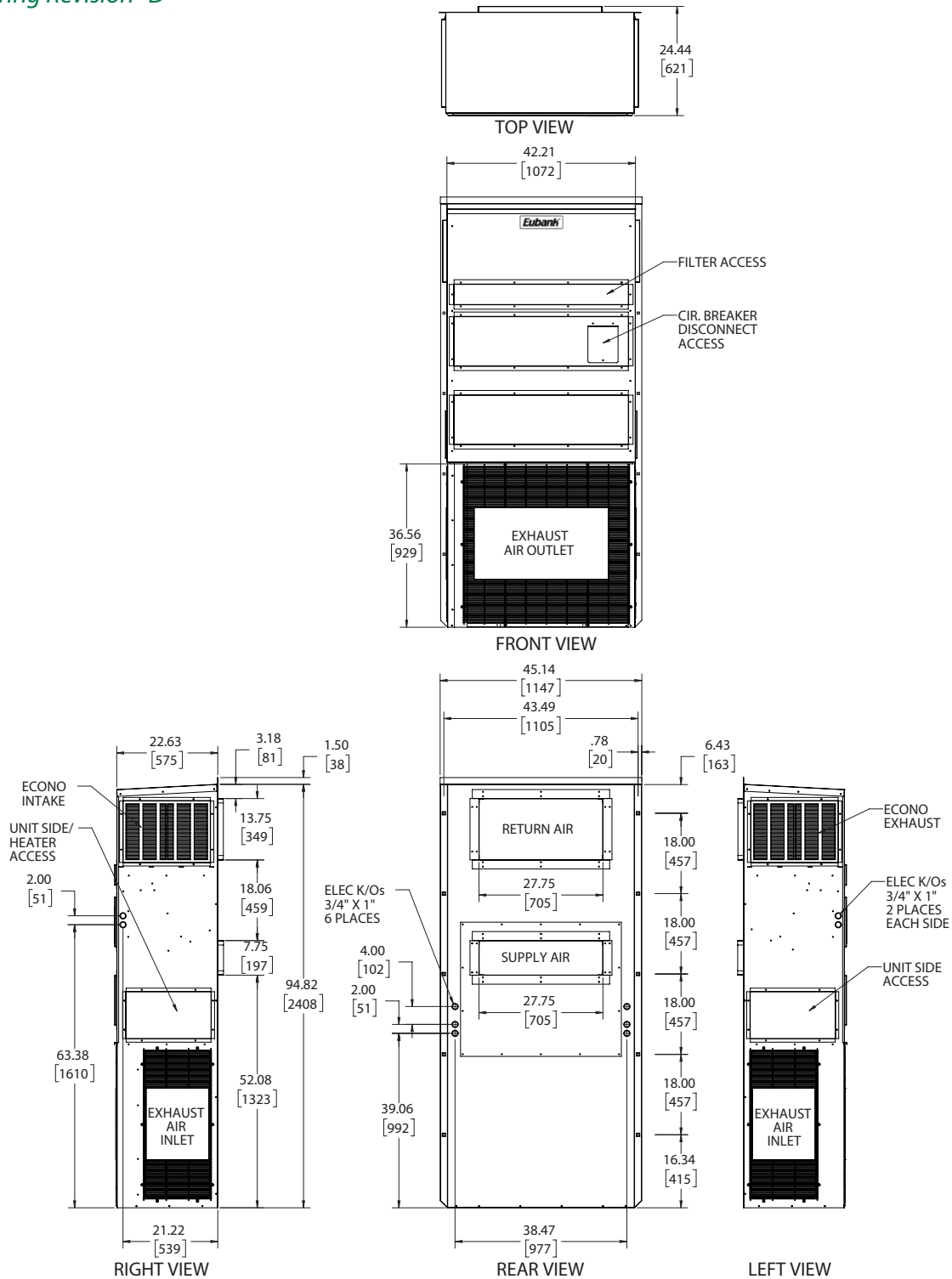

Installation Weight

EAH1036A	Base	w/Economizer	w/3 Phase	w/Economizer & 3 Phase
Pounds	535	558	588	611
Kilograms	243	253	267	277

Filter Size

EAH1036A	INCHES	MILLIMETERS	PART NUMBER	FILTERS PER UNIT	MERV RATING
RETURN AIR FILTER	36½ x 22 x 2	927 x 559 x 51	80162	1	8 (STD)

Note: All overall outside dimensions are given with +/- .250" (6mm) tolerance.

Dimensional Data - EAH1042A, EAH1048A & EAH2042A, EAH2048A

Engineering Revision "D"

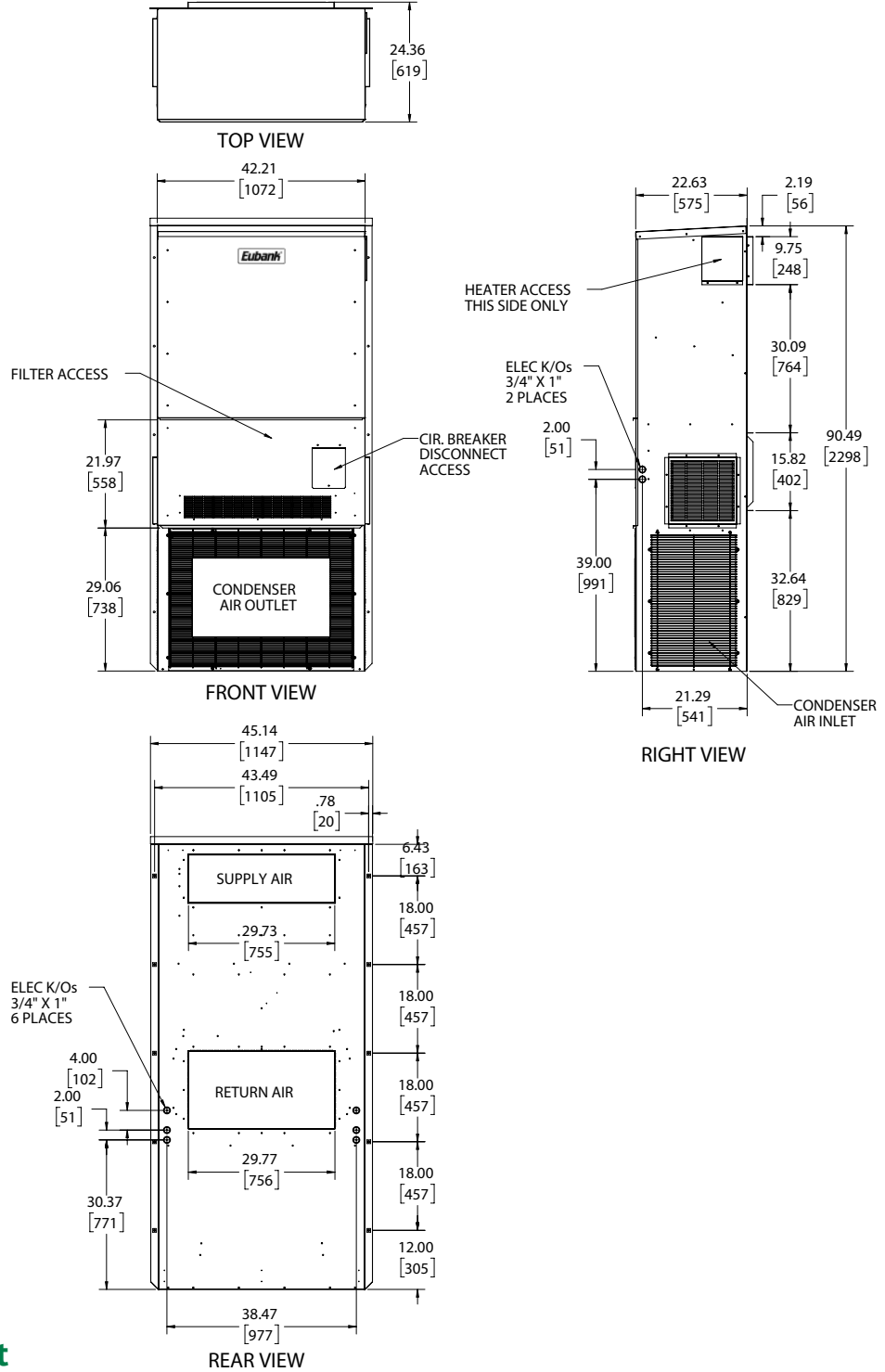

Installation Weight

EAH1042A EAH1048A EAH2042A EAH2048A	Base	w/Economizer	w/3 Phase	w/Economizer & 3 Phase
Pounds	469	492	522	545
Kilograms	213	223	237	247

Filter Size

EAH1042A/1048A EAH2042A/2048A	INCHES	MILLIMETERS	PART NUMBER	FILTERS PER UNIT	MERV RATING
RETURN AIR FILTER	36½ x 22 x 2	927 x 559 x 51	80162	1	8 (STD)

Note: All overall outside dimensions are given with +/- .250" (6mm) tolerance.

Dimensional Data - EAH1060A & EAH2060A

Engineering Revision "D"

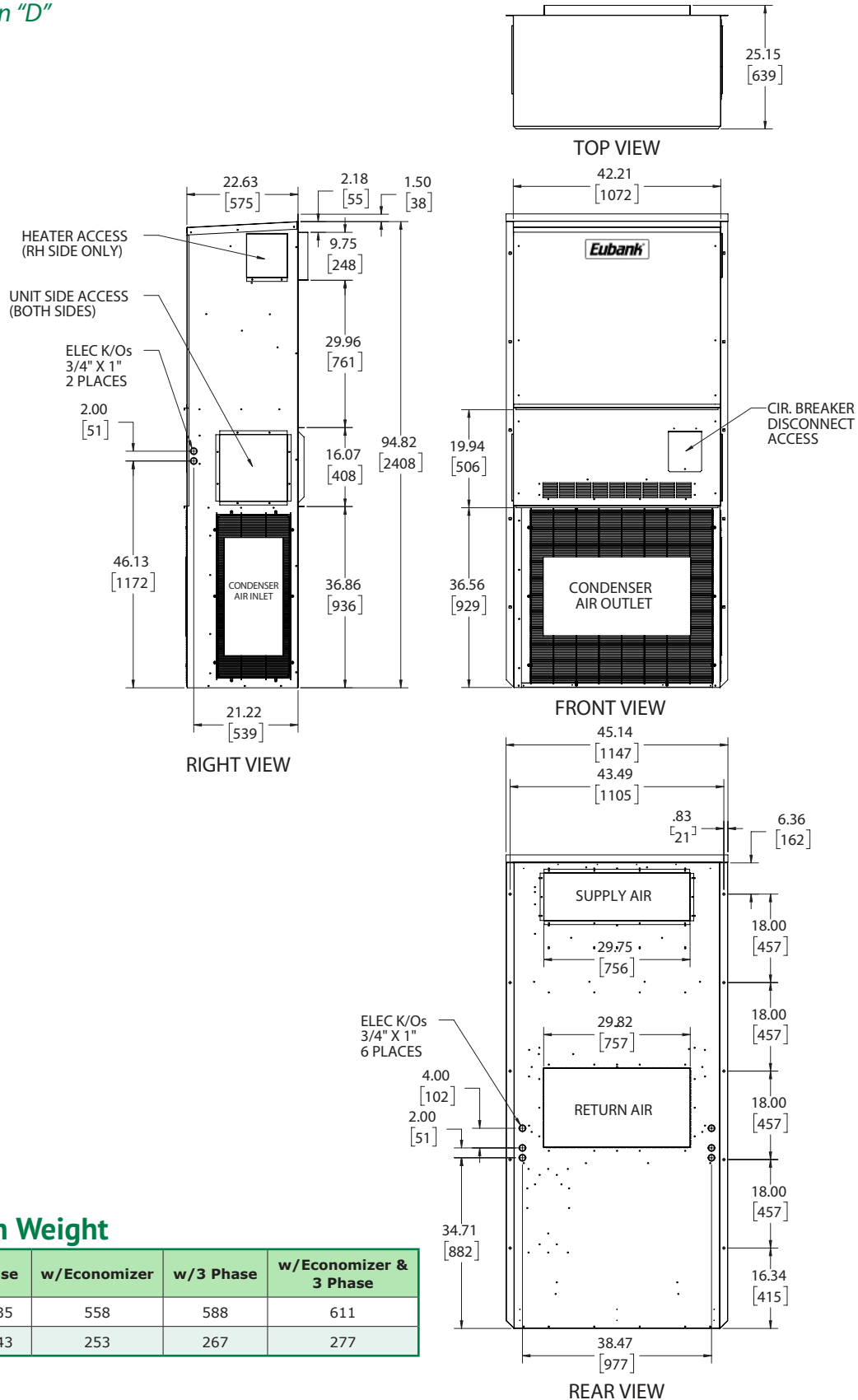

Installation Weight

EAH1060H EAH2060H	Base	w/Economizer	w/3 Phase	w/Economizer & 3 Phase
Pounds	535	558	588	611
Kilograms	243	253	267	277

Filter Size

EAH1060H EAH2060H	INCHES	MILLIMETERS	PART NUMBER	FILTERS PER UNIT	MERV RATING
RETURN AIR FILTER	36 1/2 x 22 x 2	927 x 559 x 51	80162	1	8 (STD)

Note: All overall outside dimensions are given with +/- .250" (6mm) tolerance.

Dimensional Data - EAH1060A 3T5 & 5T5 Center Supply/Top Return

Engineering Revision "D"

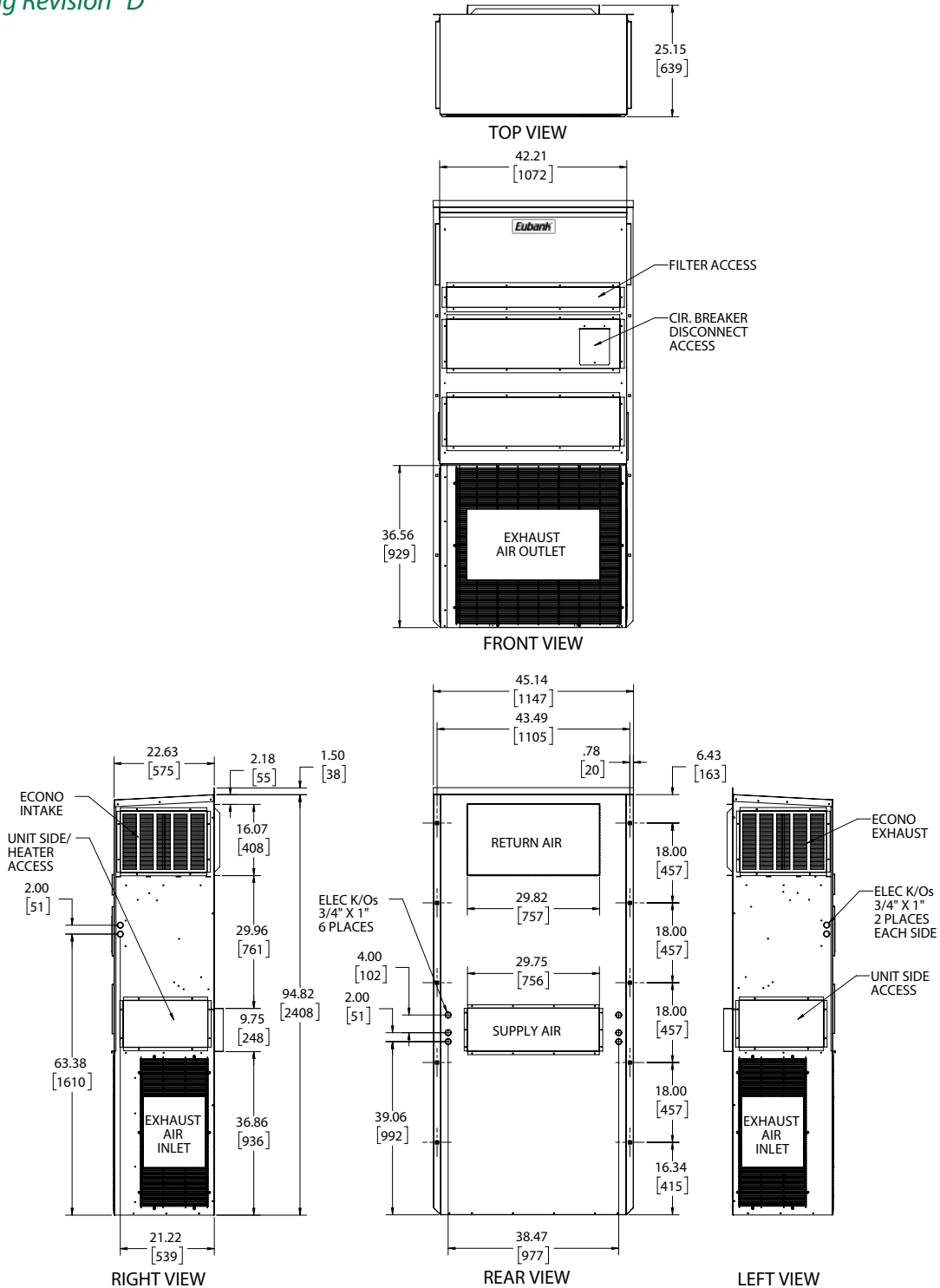

Installation Weight

EAH1060A	Base	w/Economizer	w/3 Phase	w/Economizer & 3 Phase
Pounds	535	558	588	611
Kilograms	243	253	267	277

Filter Size

EAH1060A	INCHES	MILLIMETERS	PART NUMBER	FILTERS PER UNIT	MERV RATING
RETURN AIR FILTER	36½ x 22 x 2	927 x 559 x 51	80162	1	8 (STD)

Note: All overall outside dimensions are given with +/- .250" (6mm) tolerance.

Dimensional Data - EGH1072A & EGH2072A

Engineering Revision "D"

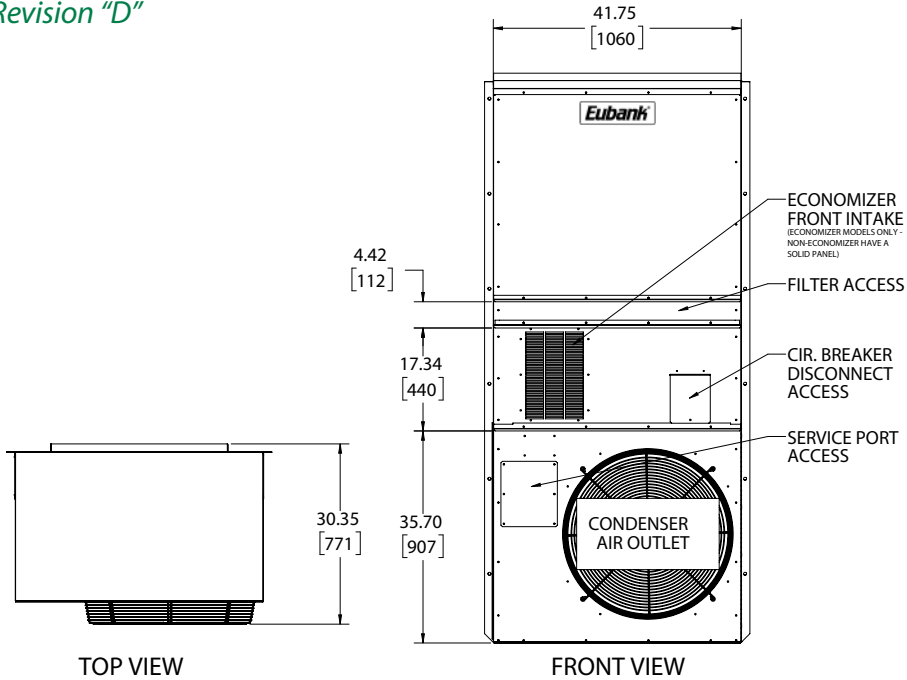

TOP VIEW

FRONT VIEW

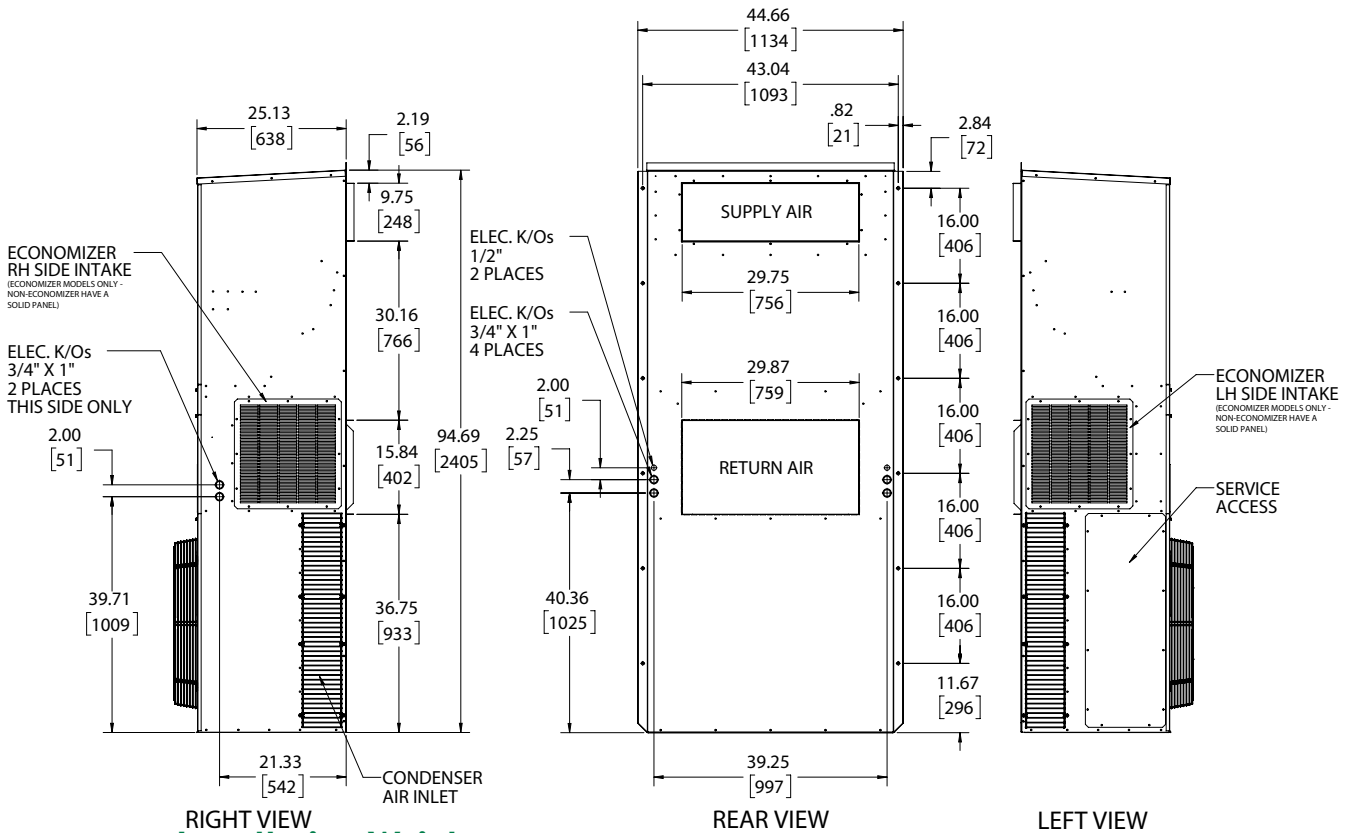

RIGHT VIEW

REAR VIEW

LEFT VIEW

Installation Weight

	Base	w/Economizer	w/3 Phase	w/Economizer & 3 Phase
Pounds	583	606	636	659
Kilograms	264	275	288	299

Filter Size

EGH1072A & EGH2072A	INCHES	MILLIMETERS	PART NUMBER	FILTERS PER UNIT	MERV RATING
RETURN AIR FILTER	24 x 30 x 2	610 x 762 x 51	93587	1	8

Note: All overall outside dimensions are given with +/- .250" (6mm) tolerance.

Dimensional Data - EAH1060A/2060A & EGH1072A/2072A Center Supply/Top Return

Engineering Revision "C"

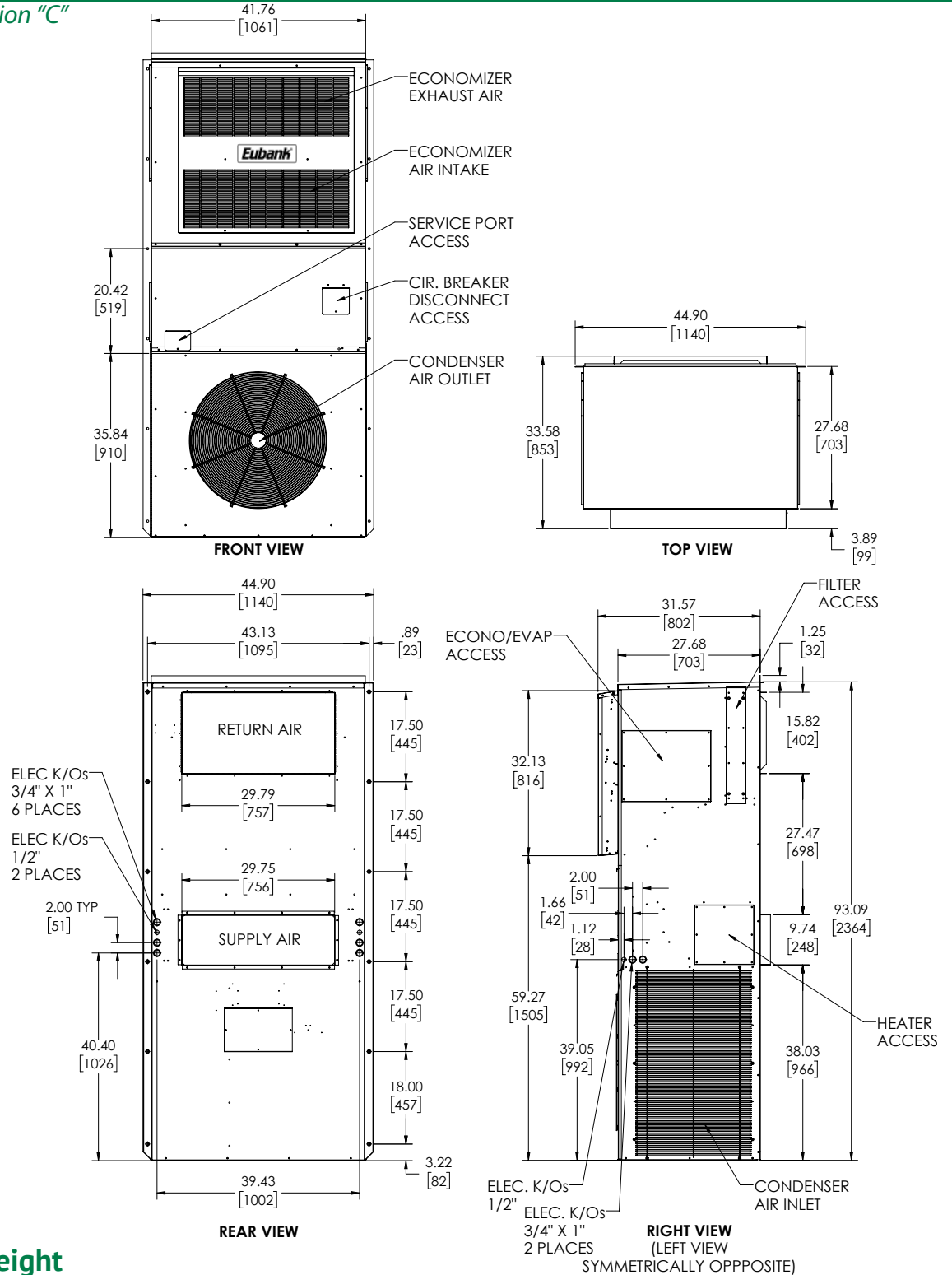

Installation Weight

EAH1060A/2060A & EGH1072A/2072A Center Supply/Top Return	Base	w/Economizer	w/3 Phase	w/Economizer & 3 Phase
Pounds	682	705	735	758
Kilograms	309	321	333	344

Filter Size

EAH1060A/2060A & EGH1072A/2072A Center Supply/Top Return	INCHES	MILLIMETERS	PART NUMBER	FILTERS PER UNIT	MERV RATING
RETURN AIR FILTER	20 x 22 x 2	508 x 559 x 51	93275	1	8

Note: All overall outside dimensions are given with +/- .250" (6mm) tolerance.

Notes

Please consult the Eubank® website at www.EubankWallmount.com for the latest product literature. Detailed dimensional data is available upon request. A complete warranty statement can be found in each product's Installation/Operation Manual, on our website or by contacting Eubank at 229-273-3636. As part of the Eubank continuous improvement program, specifications are subject to change without notice.



P.O. Box 400 • Cordele, GA 31010
156 Seedling Drive • Cordele, GA 31015
Ph: 229-273-3636 • Fax: 229-273-5154
Email: EubankOrders@airxcs.com • Internet: www.EubankWallmount.com

